



# Sync.

## Smart Home Alarm

GB - Manual  
DE - Bedienungsanleitung  
FR - Mode d'emploi  
IT - Manuale Utente  
ES - Manual de usuario



**(GB)**

Thank you for choosing the Yale Sync Smart Home Alarm system. This simple to install system has been design with the user in mind, just follow these simple steps:

**(DE)**

Vielen Dank, dass Du Dich für ein wireless Yale Sync Smart Home Alarm entschieden hast. Dieses einfach zu installierende System wurde so konzipiert, dass Du es genau an Deine individuellen Anforderungen anpassen kannst. Folg einfach den wenigen Schritten:

**(FR)**

Merci d'avoir choisi le système d'alarme Yale Sync. Pensé pour l'utilisateur, ce système s'installe en toute simplicité, suivez simplement les étapes suivantes :

**(IT)**

Grazie per aver scelto il sistema di allarme Yale Sync Smart Home. Questo sistema, semplice di allarme, è stato progettato per renderne facile l'utilizzo per l'utente, è sufficiente seguire questi semplici passaggi:

**(ES)**

Gracias por elegir el Sistema de Yale Sync Smart Home Alarm system. Este sistema fácil de instalar ha sido diseñado teniendo en mente al usuario, sólo tienes que seguir estos sencillos pasos:

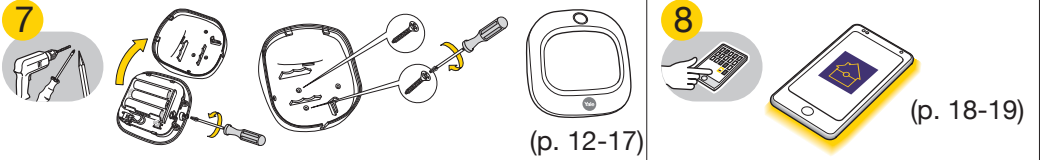
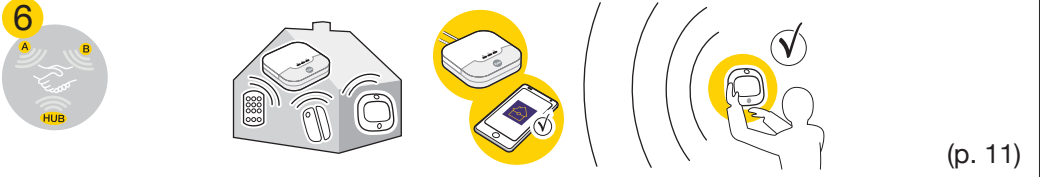
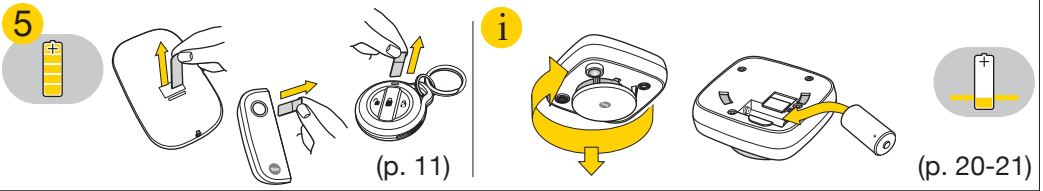
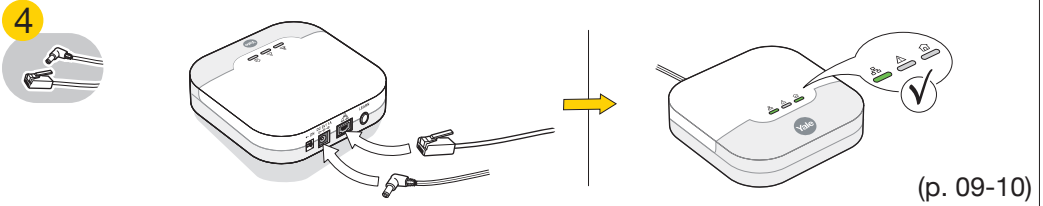
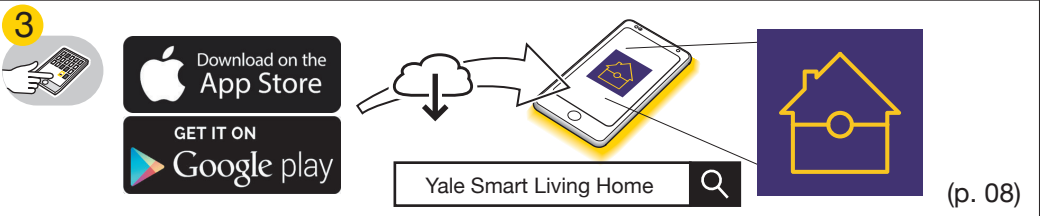
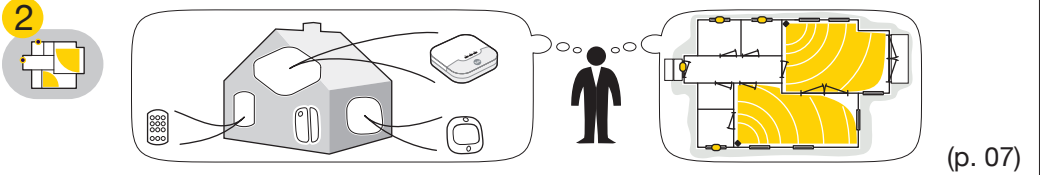
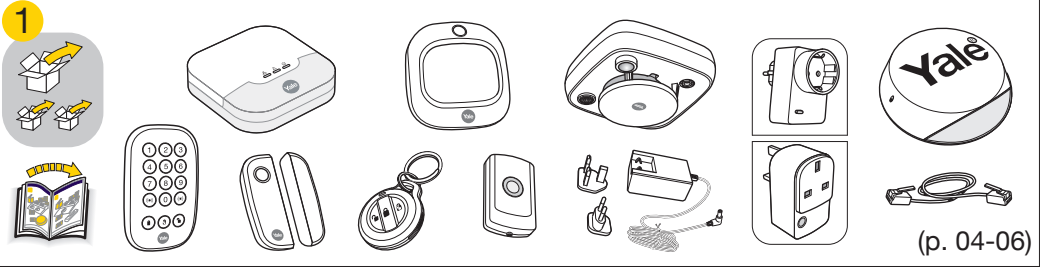



(GB) How does it work - (DE) Wie es funktioniert - (FR) Comment ça marche - (IT) Come funziona - (ES) Cómo funciona

1

IA-HUB

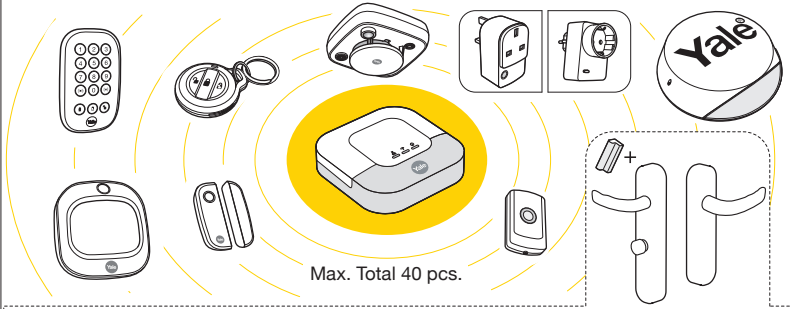

(GB) Please check which SDL is available in your country on [www.yalelock.com](http://www.yalelock.com)  
 (DE) in Deinem Land verfügbare Smarte Tüschlösser auf [www.yalelock.com](http://www.yalelock.com).  
 (FR) Veuillez vérifier quelle serrure connectée est disponible dans votre pays sur [www.yalelock.com](http://www.yalelock.com).  
 (IT) Per favore, verifica quale serratura digitale è disponibile nella tua nazione su [www.yalelock.com](http://www.yalelock.com).  
 (ES) Por favor, consultar cuál de las SDL está disponible en tu país en [www.yalelock.com](http://www.yalelock.com)

AC-KP

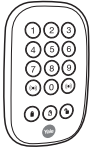

	+ PIN CODE
Disarm	
Part-Arm	
Full-Arm	

Panic button

(DE) Panikknopf  
 (FR) Bouton panique  
 (IT) Pulsante antipanico  
 (ES) Botón de pánico



AC-DC

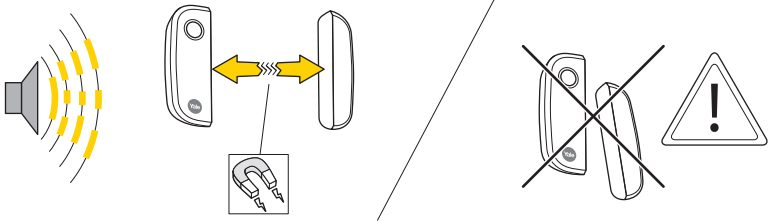

AC-PIR



AC-PETPIR

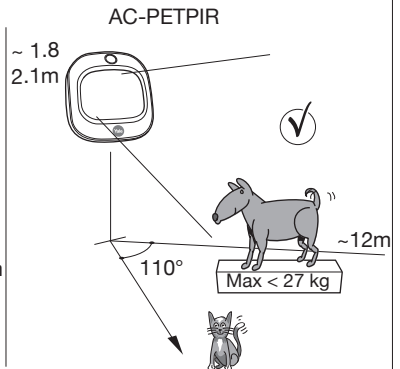
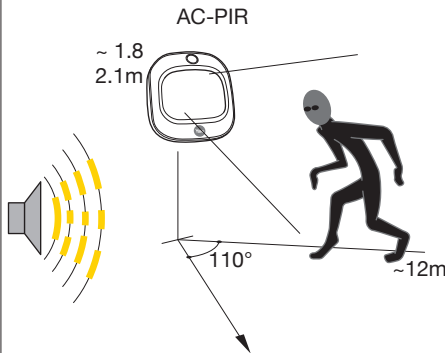

1



AC-KF

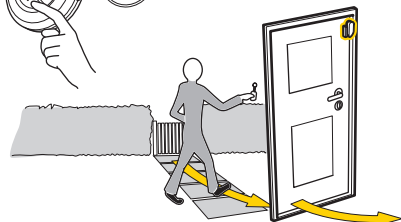
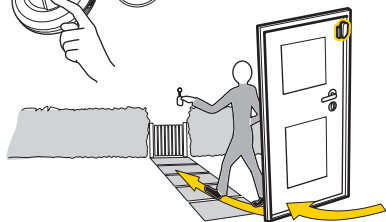

AC-PB

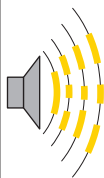

>3sec.<  
Hold



AC-PSD

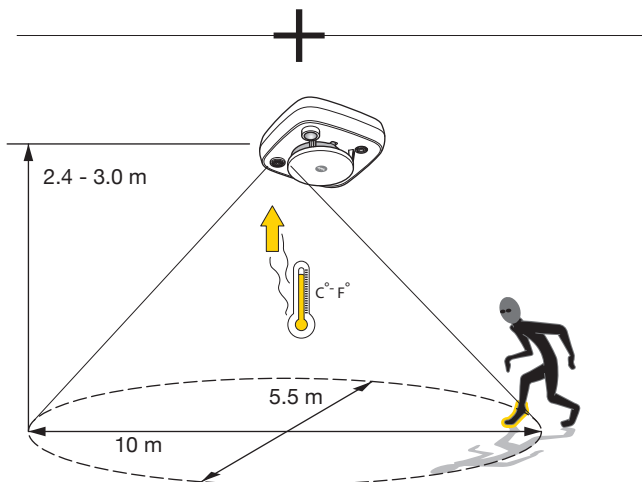
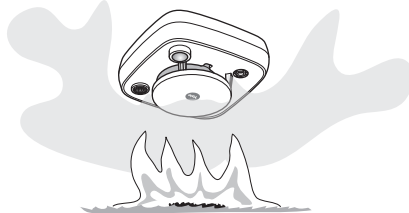
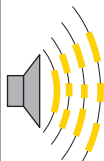



1

AC-PS

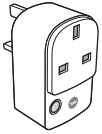

AC-PS-EU

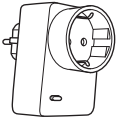

ON / OFF

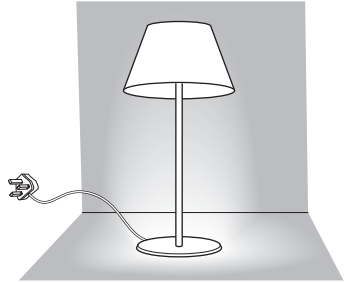
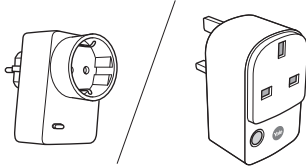

Smart Lock

+

Sync Lock  
Module AC-LM



+

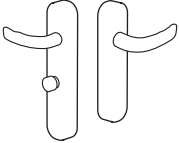

(GB) Please check which SDL is available in your country on [www.yalelock.com](http://www.yalelock.com)  
(DE) in Deinem Land verfügbare Smarte Tüschlösser auf [www.yalelock.com](http://www.yalelock.com).  
(FR) Veuillez vérifier quelle serrure connectée est disponible dans votre pays sur [www.yalelock.com](http://www.yalelock.com)  
(IT) Per favore, verifica quale serratura digitale è disponibile nella tua nazione su [www.yalelock.com](http://www.yalelock.com)  
(ES) Por favor, consultar cuál de las SDL está disponible en tu país en [www.yalelock.com](http://www.yalelock.com)

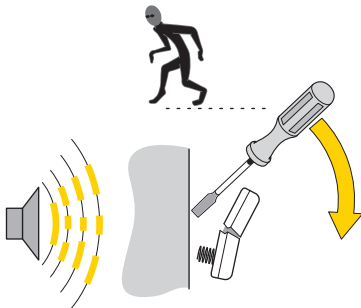
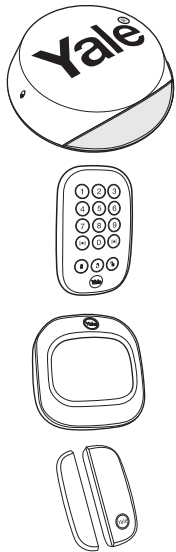
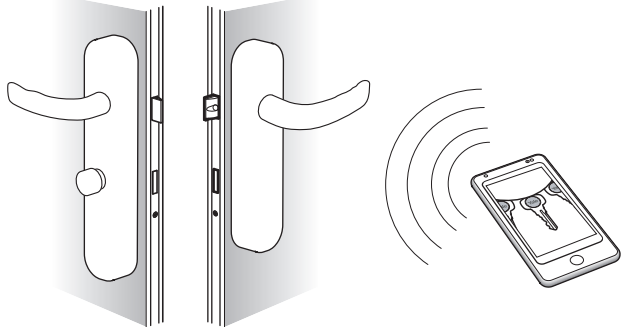

(GB) Tamper alarm  
(DE) Sabotagealarm  
(FR) Alarme autoprotection  
(IT) Allarme manomissione  
(ES) Alarma antisabotaje

i

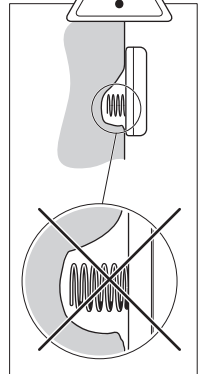
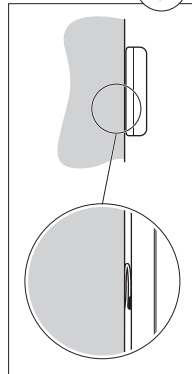

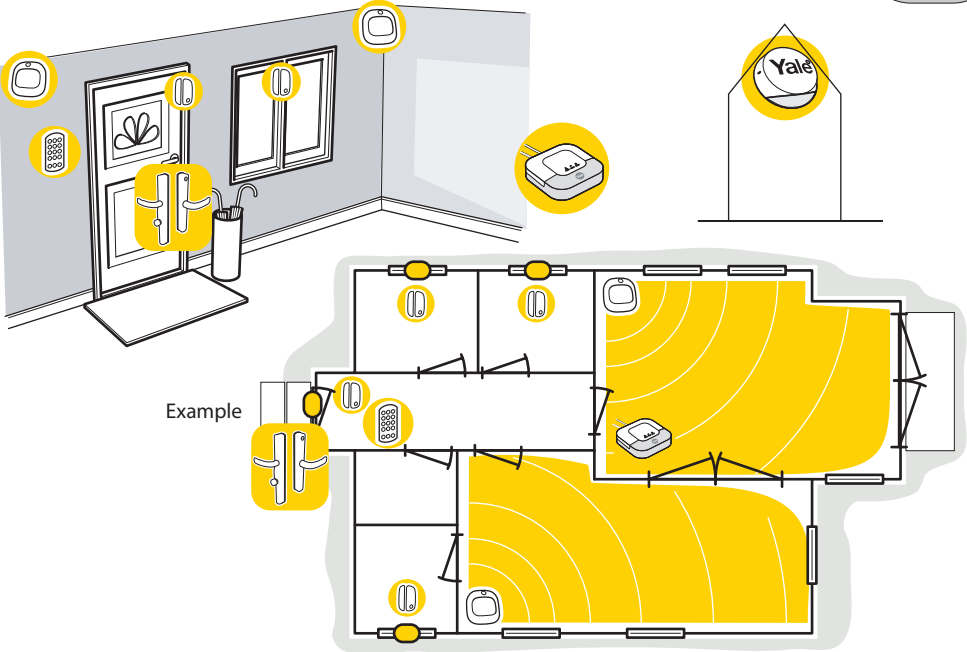

Example

				Pet-PIR	

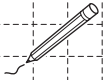
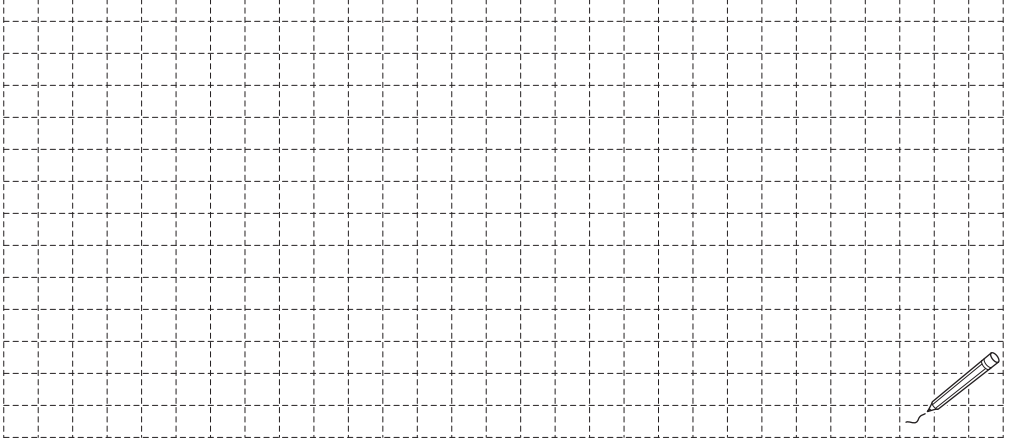



3

(GB) App download - (DE) App Download - (FR) Télécharger l'application - (IT) Scarica l'App - (ES) Descargar la App

Yale Smart Living Home



Download on the  
App Store

IOS 9.0 +

GET IT ON  
Google play

Android 4.2 +

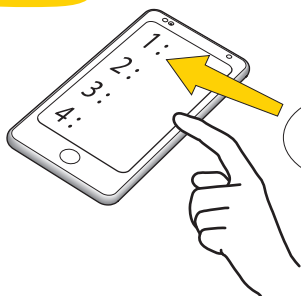

Serial No.

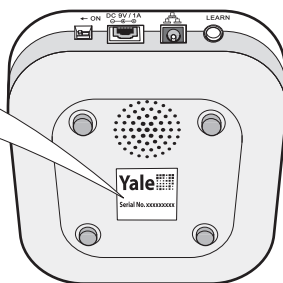

i

**GB** Please register the hub within one hour of power up, otherwise the app "authentication error" will appear. Re-boot the hub (including switch off/on the back up battery) and start the process again if necessary.

**DE** Bitte registrier den Hub innerhalb einer Stunde nach dem Einschalten. Andernfalls wird der App-Authentifizierungsfehler angezeigt. Starte den Hub neu (einschließlich Aus- / Einschalten der Pufferbatterie), und starte den Vorgang ggf. erneut.

**FR** Veuillez enregistrer la centrale dans l'heure qui suit sa mise sous tension. Si ce délai est dépassé, l'application affichera une erreur d'authentification. Dans ce cas, redémarrez la centrale (pensez à éteindre et rallumer la batterie de secours) et recommencez l'enregistrement.

**IT** Registrare l'hub entro un'ora dall'accensione, altrimenti verrà visualizzato l'errore di autenticazione dell'applicazione. Riavviare l'hub (incluso spegnimento / accensione della batteria di backup) e riavviare il processo se necessario.

**ES** Registra el hub en el plazo de una hora tras encenderlo, de lo contrario aparecerá el "error de autenticación" de la aplicación. Reinicia el hub (apaga y enciende el interruptor de la batería de respaldo también) y vuelve a iniciar el proceso en caso necesario.







1

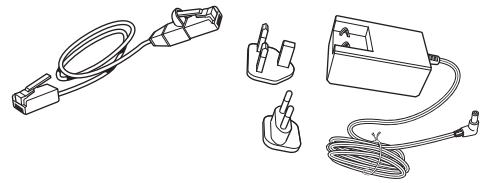
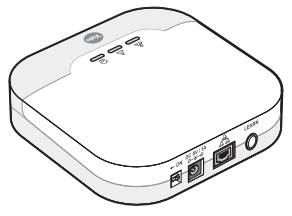

2

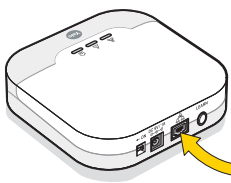

3

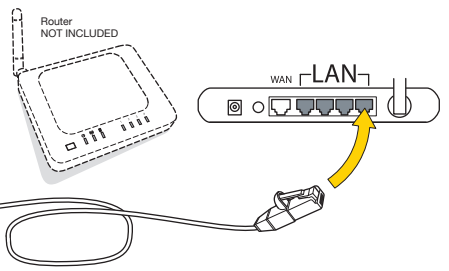

4

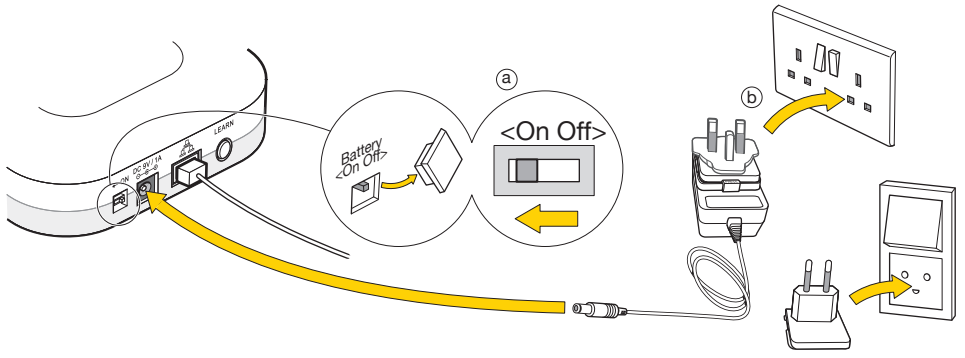

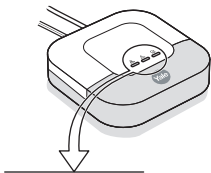
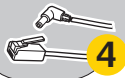

<p><b>Network,</b> Shows server connection status.</p> <p><b>Netzwerk,</b> Zeigt den Verbindungsstatus zum Yale Server an.</p> <p><b>Réseau,</b> Indique l'état de connexion au serveur.</p> <p><b>Rete,</b> Mostra lo stato della connessione con il server.</p> <p><b>Red,</b> Muestra el estado de conexión del servidor.</p>	
<p><b>Fault Status,</b> Shows fault status and AC failure warning.</p> <p><b>Fehlerstatus,</b> Zeigt eine Warnung zu Fehlerstatus und Stromausfall an.</p> <p><b>État de défaut,</b> Indique un défaut du système (coupure de courant, autoprotection, batterie de secours de la centrale ou batterie d'un détecteur faible).</p> <p><b>Stato di errore,</b> Mostra lo stato di errore e l'avviso di interruzione di corrente.</p> <p><b>Estado de fallo,</b> Indica existencia de fallo y advierte de fallo de alimentación.</p>	<p>System normal.</p>
<p><b>Alarm Mode,</b> Shows arming status.</p> <p><b>Alarmmodus,</b> Zeigt den Aktivierungsstatus an.</p> <p><b>Mode d'alarme,</b> Indique le statut d'armement du système.</p> <p><b>Modalità di allarme,</b> Mostra lo stato di inserimento dell'allarme.</p> <p><b>Modo de alarma,</b> Muestra el estado de la alarma.</p>	<p>Fully Armed</p> <p>Part Armed</p> <p>Disarmed</p>

GB: Re-boot - DE: Neu starten - FR: Redémarrage - IT: Reboot - ES: Reiniciar

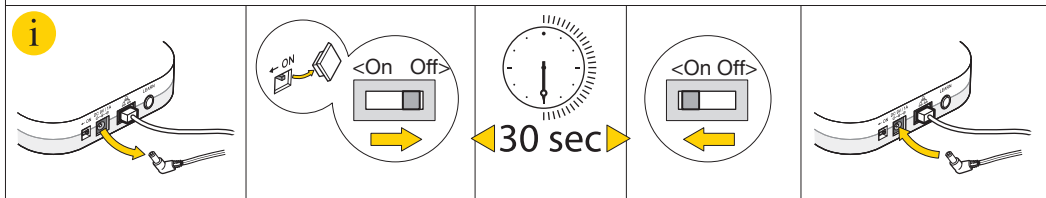

5 6



5

Remove battery strips (1)

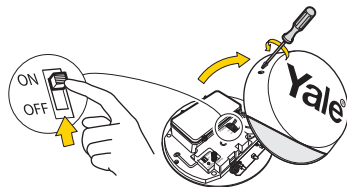
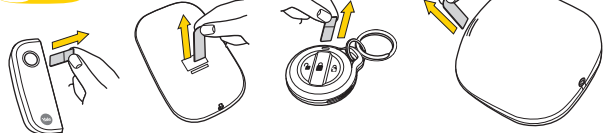

Test your planned location of components (2)

~ 200 m



Press button to test connection (3)

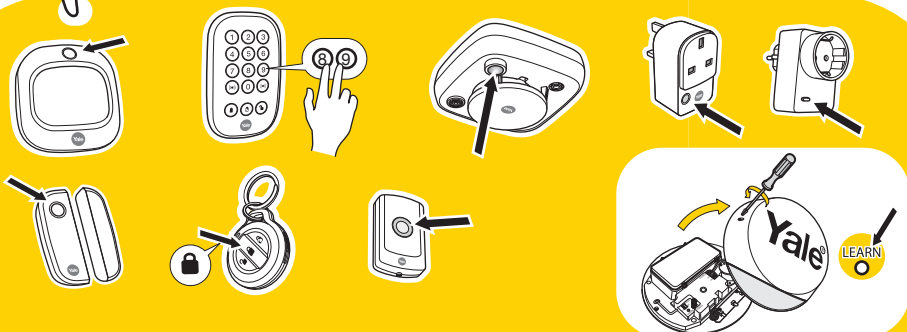

6

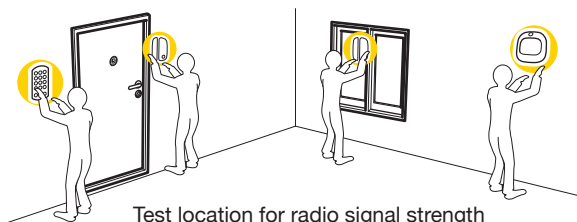

Test location for radio signal strength

(1 (DE) Entfernen der Batteriefolie - (FR) Retirez les languettes de protection des piles -

(IT) Rimuovi la linguetta della batteria - (ES) Retire la tira de la batería

(2 (DE) Teste den geplanten Standort - (FR) Testez les emplacements envisagés pour vos appareils

- (IT) Verifica la posizione scelta per i dispositivi - (ES) Comprueba la ubicación de los componentes

(3 (DE) Drück den Knopf um die Verbindung zu testen - (FR) Appuyez sur le bouton pour tester la

connexion - (IT) Premere il pulsante per verificare la connessione -

ES) Presiona el botón para comprobar la conexión

(4 (DE) Teste die Signalstärke am Anbringungsort - (FR) Testez la portée du signal dans les

emplacements envisagés - (IT) Verifica la connessione nella posizione prescelta -

(ES) Comprueba la ubicación para una correcta señal de radio

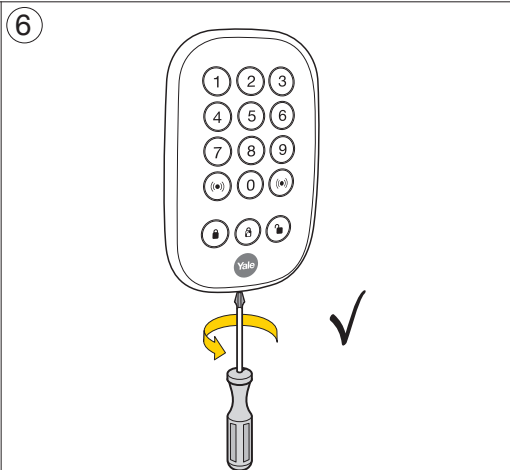
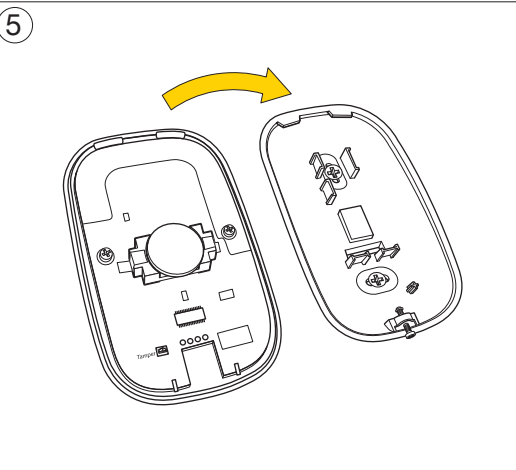
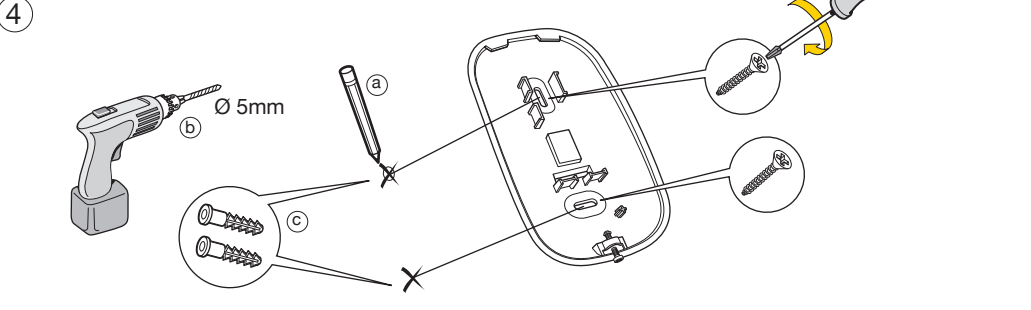
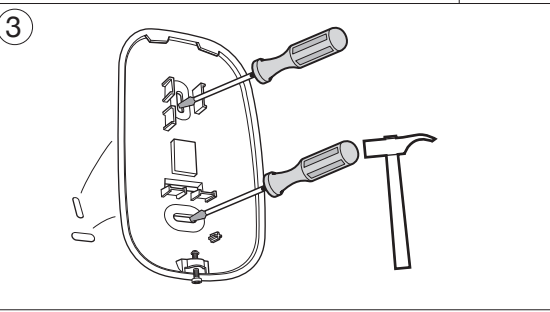
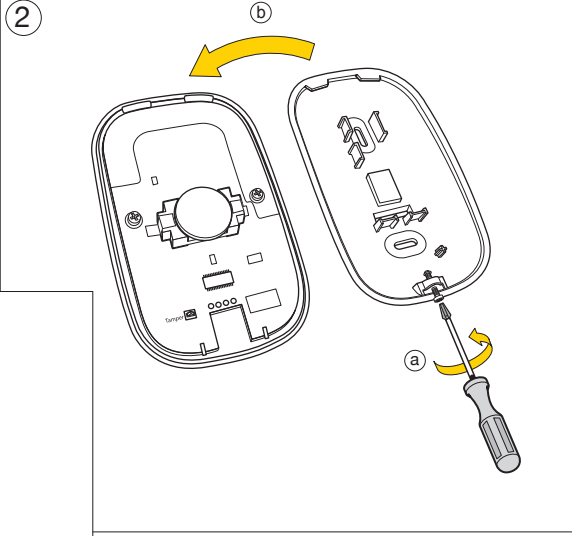
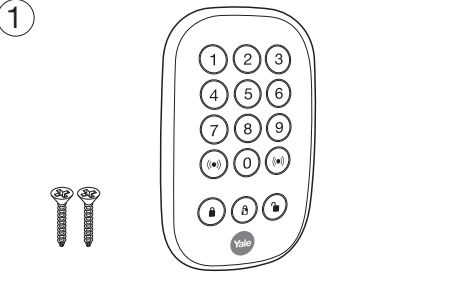

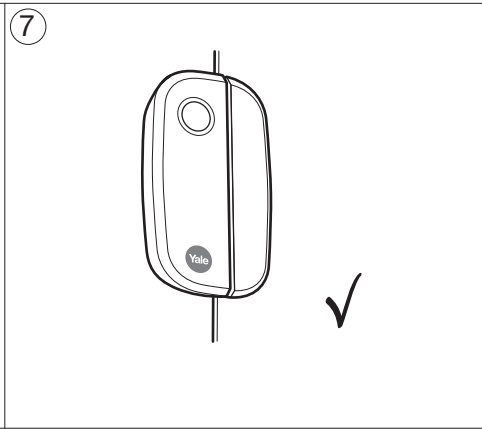
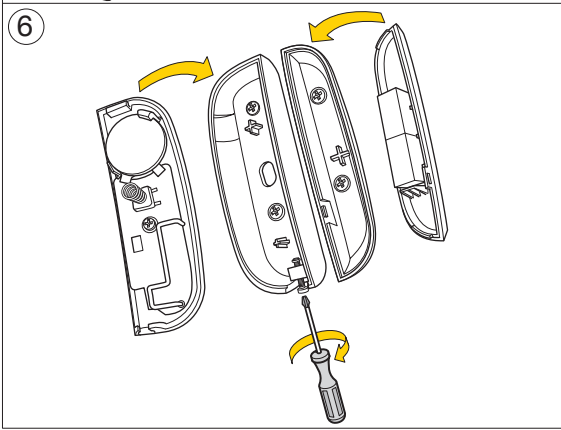
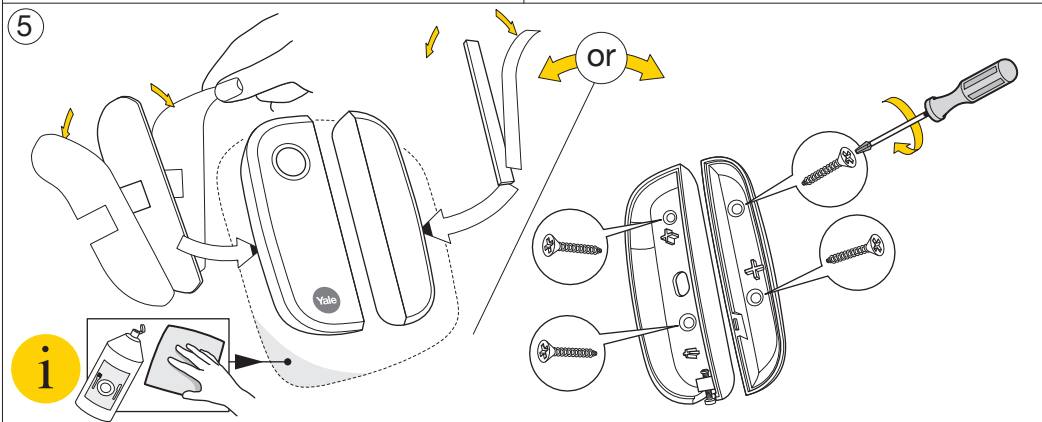
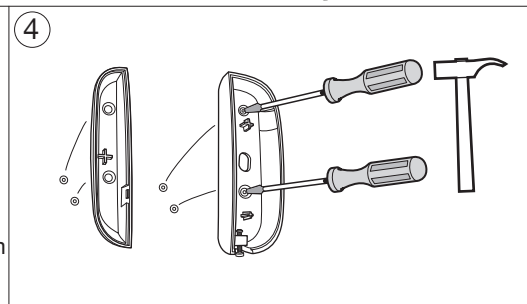
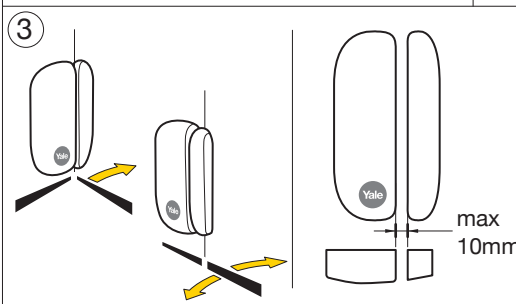
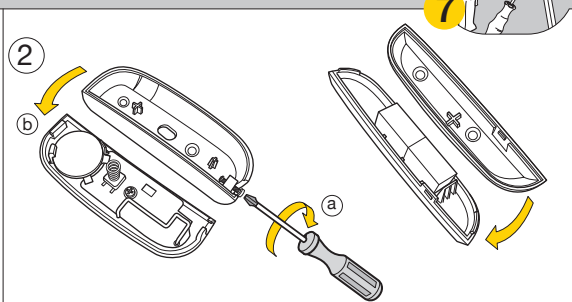
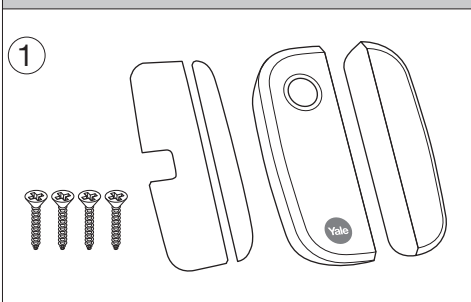



7

1



Pair / Test button (1)



2

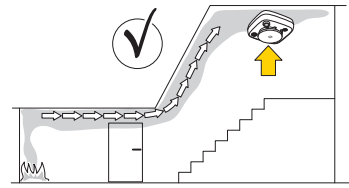

3

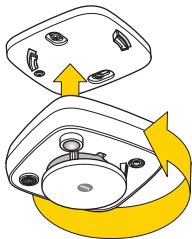
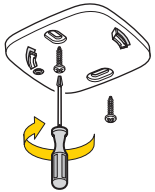

✓

Minimum 60cm

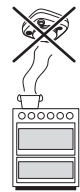
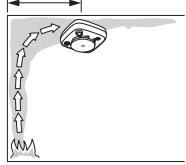

(1 (DE) Verbinden/Testen - (FR) Bouton d'appairage/test - (IT) Associazione/pulsante per il test - (ES) Vincular/Botón de prueba.

1



Pair / Test button (1)



2

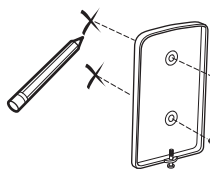
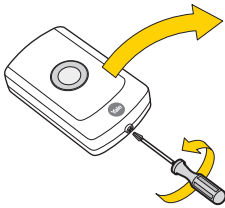

Ø 5mm

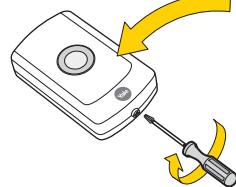
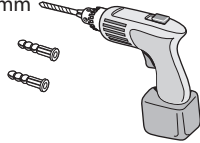

7

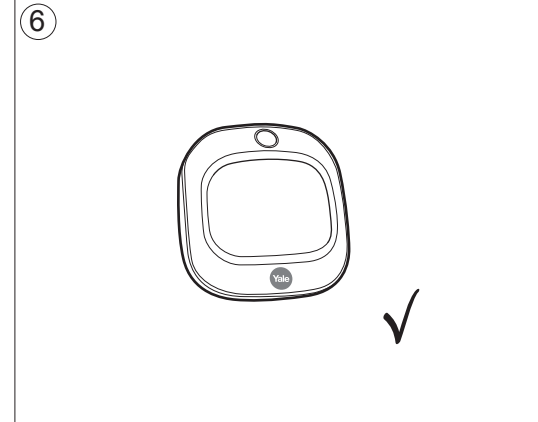
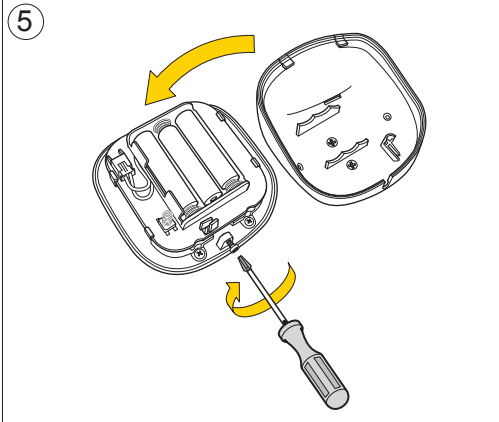
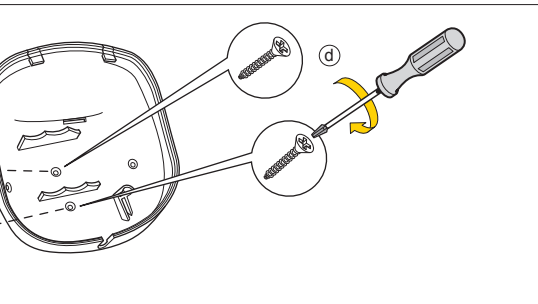
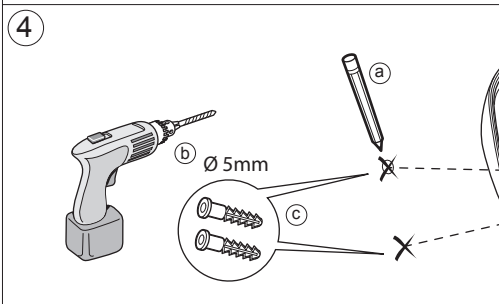
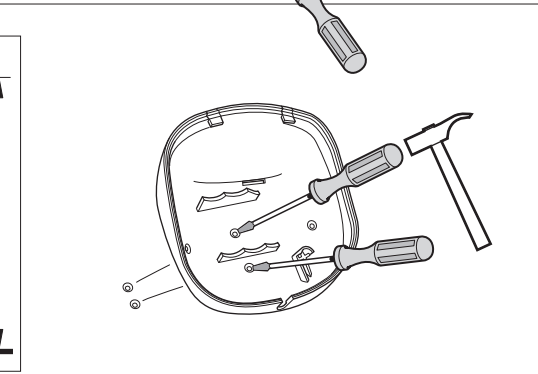
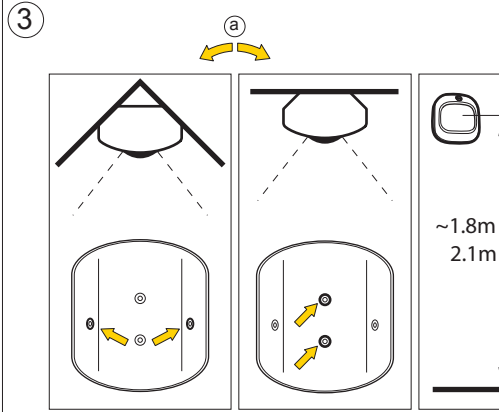
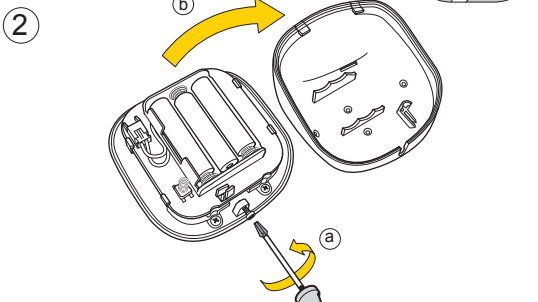
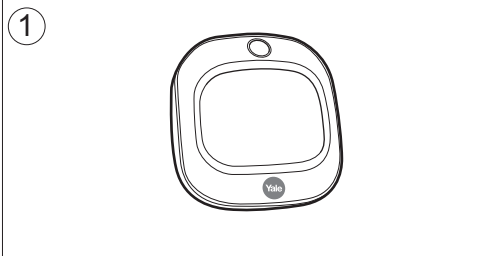

(16)

(GB) Installation - (DE) Installation - (FR) Installation - (IT) Installazione -  
(ES) Instalación



7

①

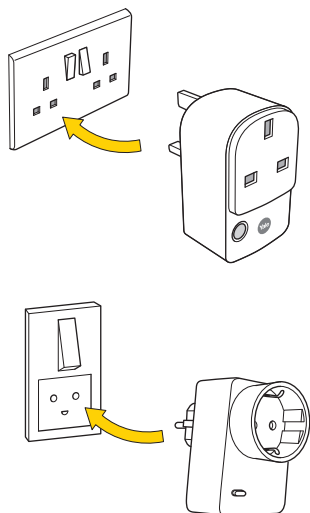

②

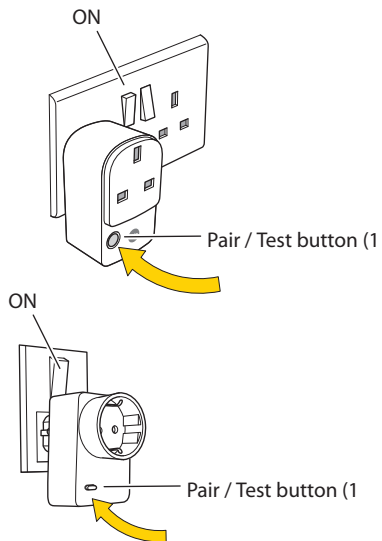

(1 (DE) Verbinden/Testen - (FR) Bouton d'appairage/test - (IT) Associazione/pulsante per il test -  
(ES) Vincular/Botón de prueba.



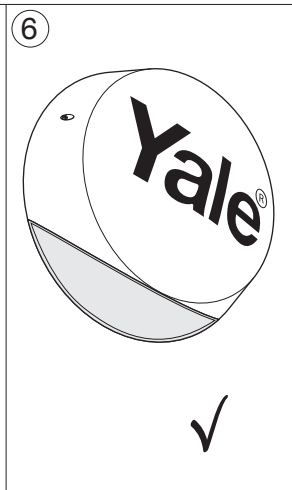
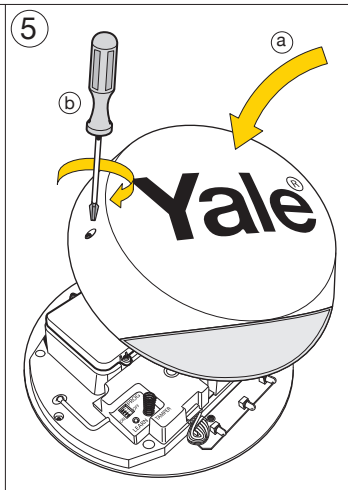
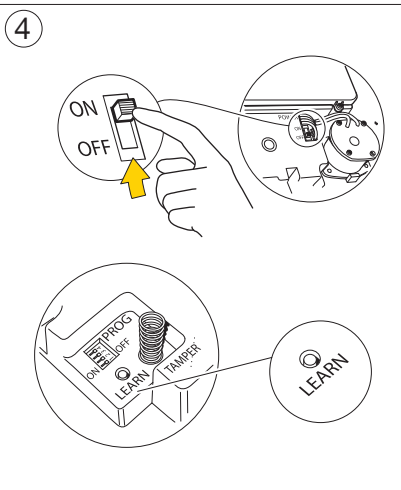
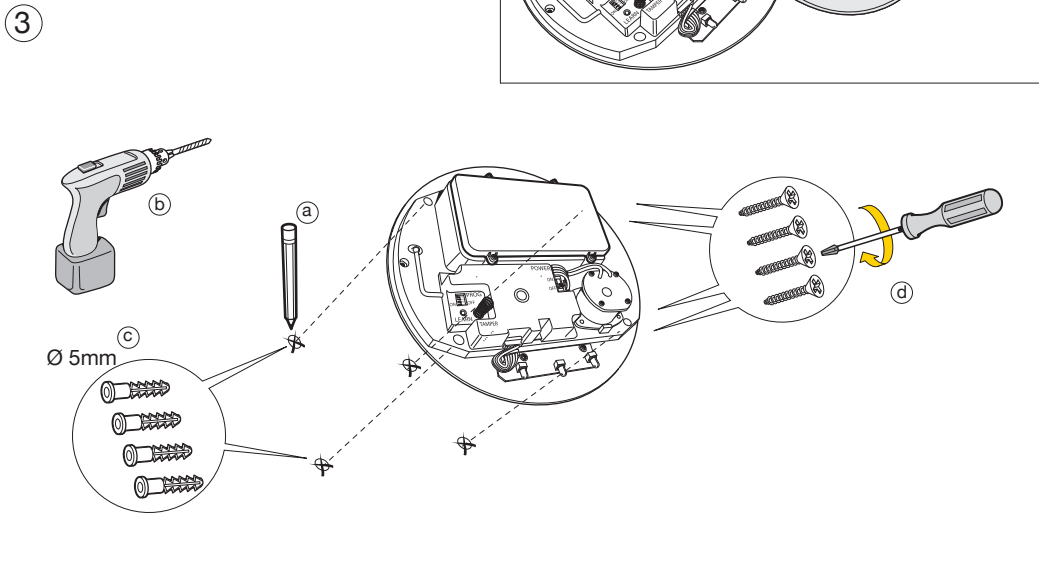
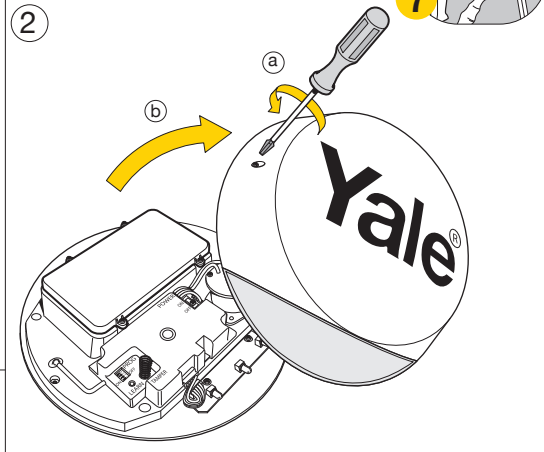
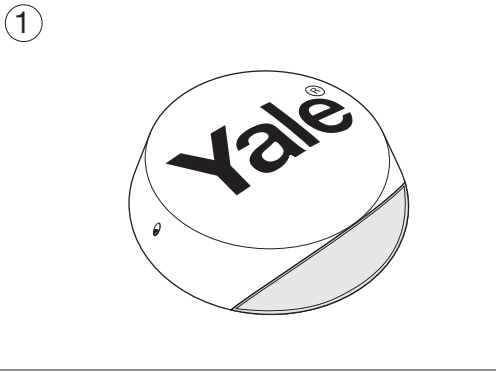



8



(GB) **Open App.** Follow instructions in the App.  
(DE) **App öffnen.** Folge der Anleitung in der App.  
(FR) **Ouvrir application.** Suivez les instructions dans l'application.  
(IT) **Apri l'app.** Seguire le istruzioni nell'app.  
(ES) **Abre la aplicación.** Sigue las instrucciones de la aplicación.



(GB) Adding new devices.  
(DE) Neue Geräte hinzufügen.  
(FR) Ajout de nouveaux appareils.  
(IT) Aggiunta di nuovi dispositivi.  
(ES) Añade nuevos dispositivos.

~200 m



Press button to test connection

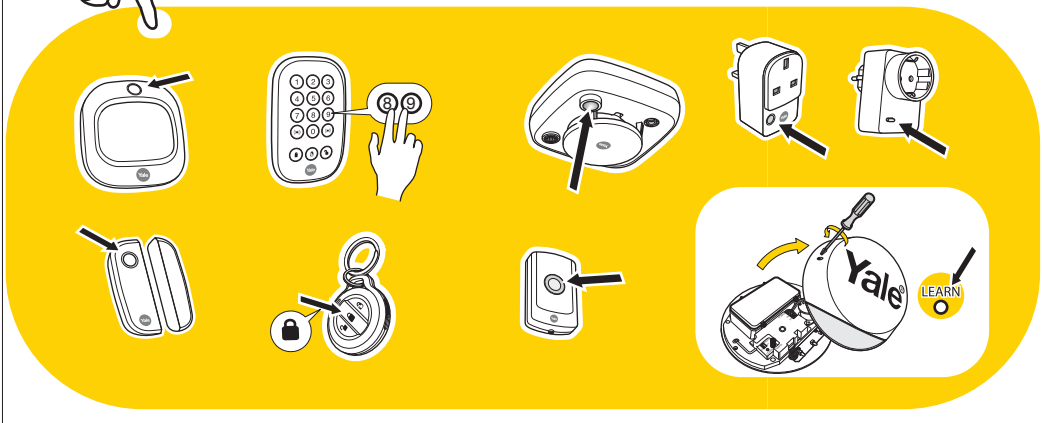

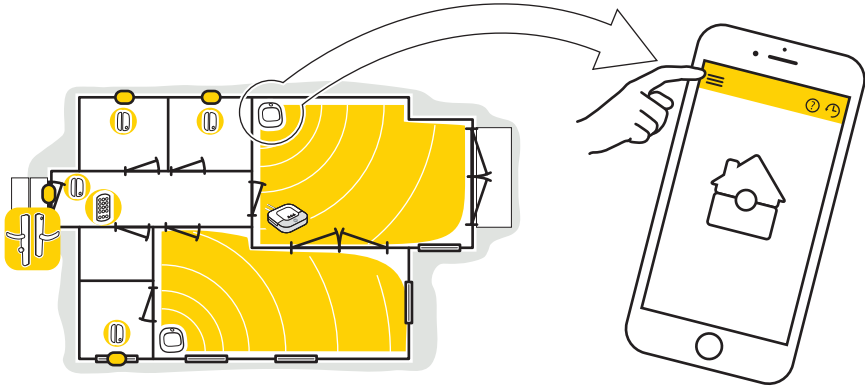

	(GB) <b>No alarm</b> - You are at home. (DE) <b>Kein Alarm</b> - Ihr seid zu Hause. (FR) <b>Alarme désarmée</b> - Vous êtes à la maison. (IT) <b>Nessun allarme</b> : sei a casa. (ES) <b>Alarma desactivada</b> - estás en casa.
	(GB) <b>Part alarm</b> - You are inside. (DE) <b>Teilalarm</b> - Ausgewählte Bereiche werden überwacht. (FR) <b>Alarme armée partiellement</b> - Vous êtes à l'intérieur. (IT) <b>Allarme parziale</b> - Sei dentro. (ES) <b>Alarma parcial</b> - estás dentro.
	(GB) <b>Full alarm</b> - Nobody at home. (DE) <b>Voller Alarm</b> - Niemand zu Hause. (FR) <b>Alarme armée totalement</b> - Personne à la maison. (IT) <b>Allarme completo</b> - Nessuno a casa. (ES) <b>Alarma completa</b> - no hay nadie en casa.

					(DE) Sensor ignoriert (FR) Détecteur ignoré (IT) Sensore ignorato (ES) Ignorar sensor
Burglar					
Entry					(DE) Sofort Alarm (FR) Alarme instantanée (IT) Sirena istantanea (ES) Alarma inmediata
Home Omit					
Home Access					(DE) Alarm nach Countdown (FR) Alarme temporisée (IT) Attiva in ritardo (ES) Alarma tras cuenta atrás
					Triggers Countdown 30 sec.

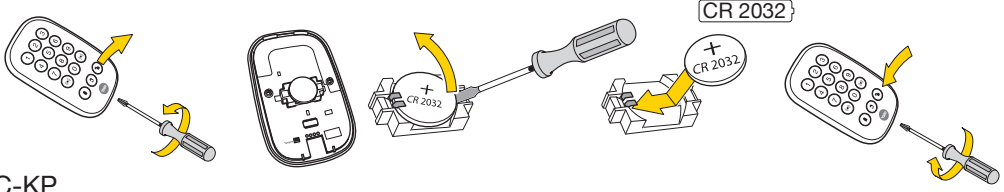
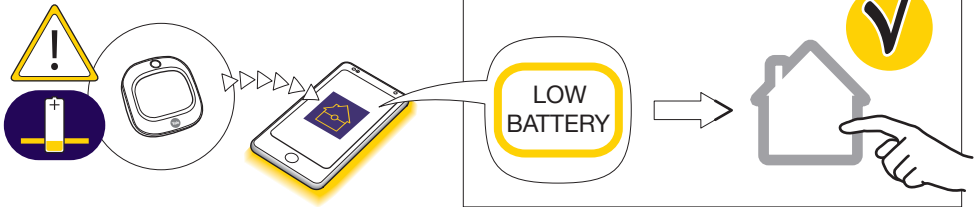

AC-KP

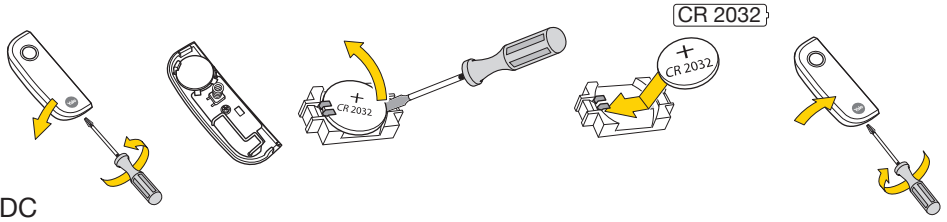

AC-DC

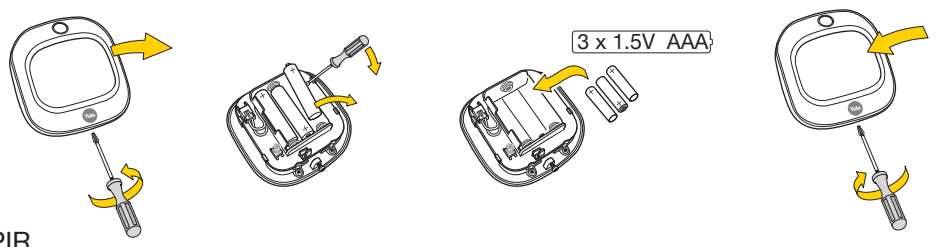

AC-PIR

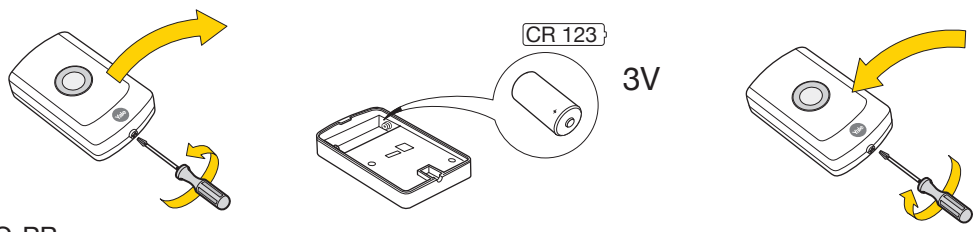

AC-PB

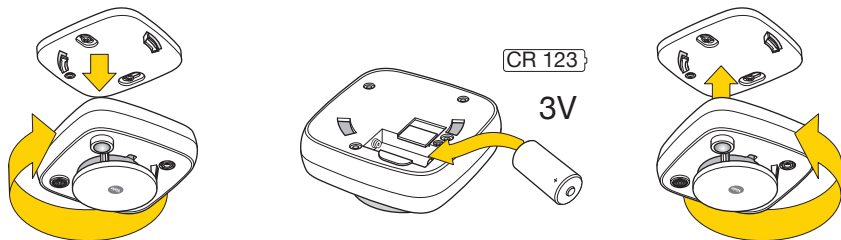

AC-PSD

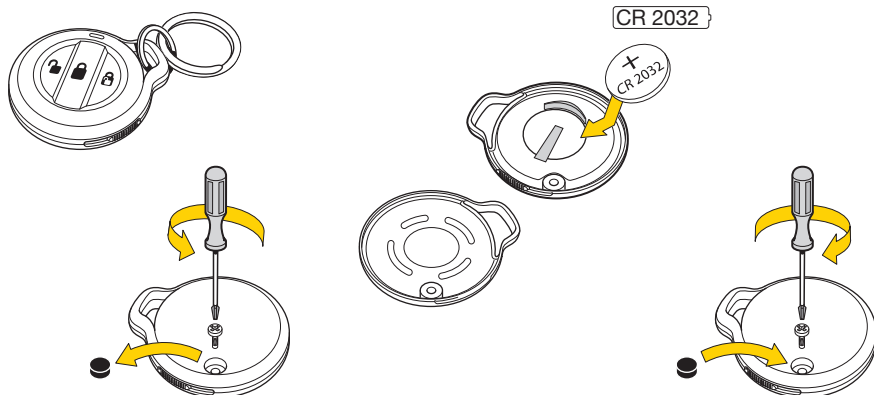

AC-KF

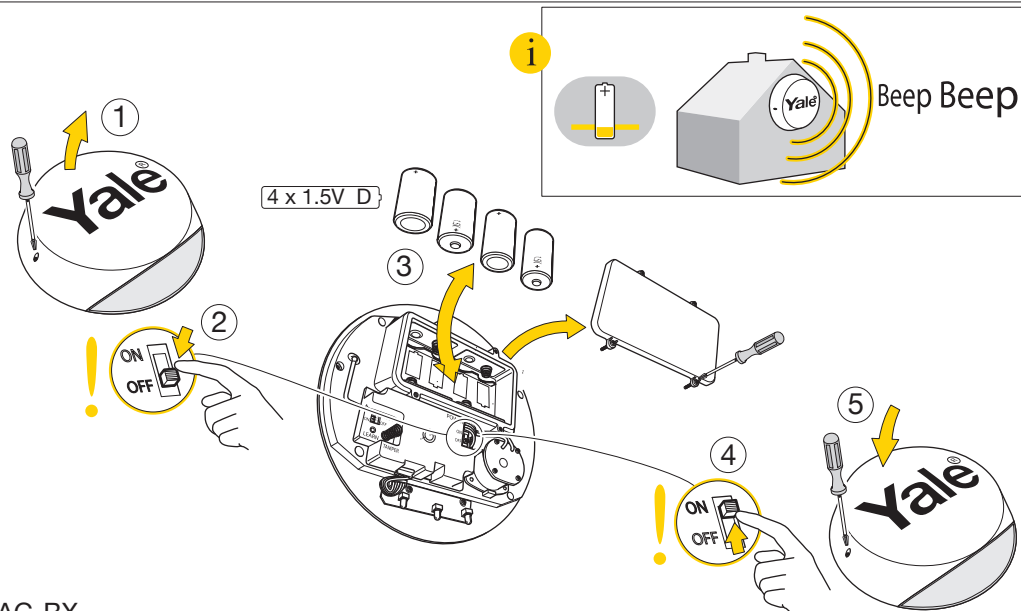

AC-BX



Product	Frequency / Band	EIRP [dBm]
AC-PANEL	F1-868-2W	17.08±3dB
IA-HUB	F1-868-2W	14.35±3dB
AC-PIR	F1-868-2W	10.4±3dB
AC-PETPIR	F1-868-2W	9.71±3dB
AC-DC	F1-868-2W	1.98±3dB
AC-KF	F1-868-2W	0.51±3dB
AC-KP	F1-868-2W	4.57±3dB
AC-BX	F1-868-2W	12.6±3dB
AC-PSD	F1-868-2W	12.95±3dB
AC-PB	F1-868-2W	14.12±3dB
AC-LM	F1-868-2W	6.47±3dB
AC-VS	F1-868-2W	1.24±3dB
AC-PS	F1-868-2W	12.32±3dB
AC-PS-EU	F1-868-2W	12.32±3dB
AC-BXG	F1-868-2W	12.6±3dB

(GB) Environment - (DE) Umgebung - (FR) Environnement - (IT) Ambiente - (ES) Ambiente

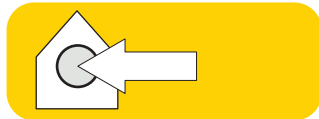

### All devices

Housings ABS/polycarbonate



-10°C to 40°C



70%

(DE) Alle Geräte , Gehäuse ABS Polycarbonat  
(FR) (FR) Tous les dispositifs. Caissons ABS / polycarbonate.  
(IT) Involucro di TUTTI i dispositivi ABS/polycarbonato  
(ES) Todos los dispositivos. Carcasas de ABS / polycarbonato.

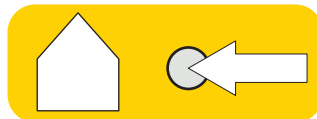

### Outdoor Siren



-20°C to 50°C



95%

(DE) Außensirene  
(FR) Sirène extérieure  
(IT) Sirena esterna  
(ES) Sirena exterior

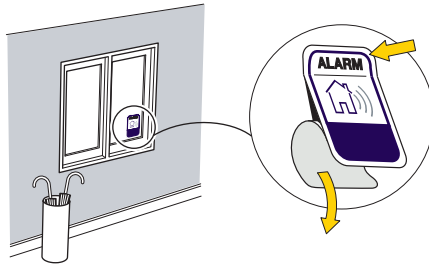

(GB) Server Information - (DE) Server Informationen - (FR) - Informations sur le serveur  
(IT) Informazioni del Server - (ES) Información del servidor

**GB:** - The SmartPhone feature requires our central server. Yale offers no guarantee on the availability of our server. Yale cannot guarantee limitless and future availability of our free server. We would contact individual users via E-mail should this situation change. In the unlikely event of server disconnection, the alarm system will continue to function (arm/disarm) using the supplied keypad accessory. Alarm Notification functions must only be used with persons who have consented to being contacted by the system. The system is not to be used to make 112 / 999 emergency calls directly. Information and illustrations are subject to changes within this document. Yale reserved the right to alter the specifications and product design at any time without notice.

**DE:** - Die App erfordert die Nutzung unseres zentralen Server. YALE übernimmt keine Garantie für die Verfügbarkeit dieses Servers. YALE kann keine Garantie für die unbegrenzte und zukünftige Verfügbarkeit unseres kostenlosen Servers übernehmen. Wir werden die Nutzer per Mail informieren, wenn sich die Situation ändert. In dem unwahrscheinlichen Fall, dass die Verbindung unterbrochen wird, funktioniert das Alarmsystem weiterhin über Tastatur bzw. Fernbedienung. Die Alarmmeldungsfunktion sollte nur mit Personen genutzt werden, welche eine Zustimmung zur Kontaktierung durch das System gegeben haben. Das System ist nicht dazu ausgelegt die Polizei 110 zu kontaktieren. Informationen und Illustrationen können bei Bedarf geändert werden. YALE behält sich alle Rechte vor Spezifikationen und das Produktdesign ohne Information zu ändern.

**FR:** - L'utilisation de l'application mobile nécessite un accès au serveur Yale. Yale ne garantit en aucun cas un accès futur illimité au serveur. Les usagers seront contactés individuellement dans l'éventualité d'un changement de situation. Dans l'éventualité d'une déconnexion du serveur, le système d'alarme continuera de fonctionner (activation/désactivation) à l'aide du clavier fourni. Seules les personnes ayant consenti à être contactées par le système doivent utiliser les fonctions de notification d'alarme. Le système d'alarme ne doit pas être utilisé pour composer directement le numéro d'urgence 112/999. Les informations et illustrations présentes dans ce document peuvent être sujettes à changement. Yale se réserve le droit de modifier les caractéristiques ainsi que le design du produit à tout moment et sans préavis.

**IT:** - L'utilizzo dell'app per Smartphone richiede l'utilizzo del nostro server. Yale non garantisce il servizio del nostro server gratuito. Yale non garantisce la disponibilità senza limiti del servizio del nostro server gratuito in futuro. Contatteremo gli utenti attraverso e-mail se questa situazione dovesse subire variazioni. Se il server dovesse subire una temporanea mancanza di servizio, il sistema di allarme potrà continuare a essere utilizzato (attivazione/disattivazione) utilizzando il tastierino a codice fornito in dotazione. Le notifiche inviate dal sistema di allarme devono essere indirizzate solo a persone che hanno acconsentito a essere contattate dal sistema. Il sistema non è predisposto per effettuare chiamate dirette al numero di emergenza 112. Le informazioni e le immagini presenti all'interno di questo documento potrebbero subire variazioni. Yale si riserva il diritto di apportare modifiche alle specifiche e al design del prodotto in qualsiasi momento senza preavviso.

**ES:** - La función Smartphone requiere de un servidor central. Yale no ofrece garantía sobre la disponibilidad de nuestro servidor. Yale no puede garantizar la disponibilidad ilimitada y el futuro de nuestro servidor gratuito. Contactaremos a través de email con los usuarios si esta situación cambia. En el improbable caso de desconexión del servidor, el sistema de alarma seguirá funcionando (armado / desarmado) a través del teclado suministrado. Las funciones de notificación de alarma sólo deben ser usadas por las personas que han dado su consentimiento para ser contactadas a través del sistema. El sistema no se debe utilizar para hacer llamadas de emergencia al 112 directamente. La información y las ilustraciones de este documento están sujetos a cambios. Yale se reserva el derecho de alterar las especificaciones y el diseño de productos en cualquier momento sin previo aviso.

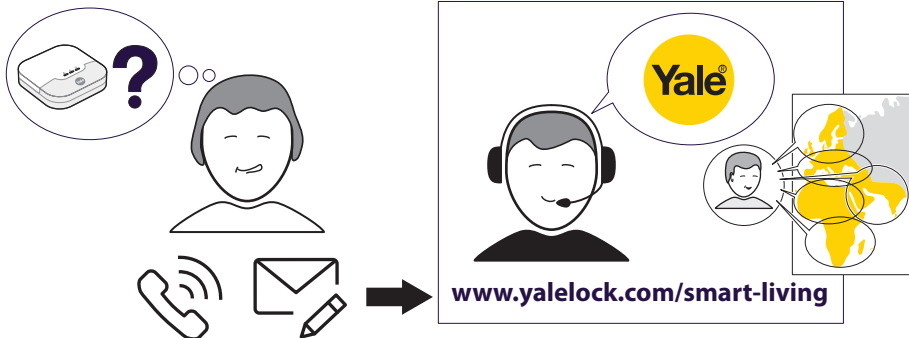

**GB:** Hereby, ASSA ABLOY Ltd., School Street, Willenhall, West Midlands, England WV13 3PW declares that the radio equipment type Sync Smart Home Alarm is in compliance with Directive 2014/53/EU. The full text of the EU declaration of conformity is available at the following internet address: [www.yalelock.com/smart-living/doc](http://www.yalelock.com/smart-living/doc)

**DE:** Hiermit erklärt ASSA ABLOY Ltd., School Street, Willenhall, West Midlands, England WV13 3PW, dass der Funkanlagentyp Sync Smart Home Alarm der Richtlinie 2014/53/EU entspricht. Der vollständige Text der EU-Konformitätserklärung ist unter der folgenden Internetadresse verfügbar: [www.yalelock.com/smart-living/doc](http://www.yalelock.com/smart-living/doc)

**FR:** Le soussigné, ASSA ABLOY Ltd., School Street, Willenhall, West Midlands, England WV13 3PW, déclare que l'équipement radioélectrique du type Sync Smart Home Alarm est conforme à la directive 2014/53/UE. Le texte complet de la déclaration UE de conformité est disponible à l'adresse internet suivante: [www.yalelock.com/smart-living/doc](http://www.yalelock.com/smart-living/doc) ••• Message à destination des professionnels ••• Si vous souhaitez installer Smart Home/ phone Alarm dans votre société, vous devez obligatoirement demander une autorisation à la Commission Nationale de l'Informatique et des Libertés.

**IT:** Il produttore, ASSA ABLOY Ltd., School Street, Willenhall, West Midlands, England WV13 3PW, dichiara che il tipo di apparecchiatura radio Sync Smart Home Alarm è conforme alla direttiva 2014/53/UE. Il testo completo della dichiarazione di conformità UE è disponibile al seguente indirizzo Internet: 22.5.2014 L 153/104 Gazzetta ufficiale dell'Unione europea IT: [www.yalelock.com/smart-living/doc](http://www.yalelock.com/smart-living/doc)

**ES:** Por la presente, ASSA ABLOY Ltd., School Street, Willenhall, West Midlands, England WV13 3PW declara que el tipo de equipo radioeléctrico Sync Smart Home Alarm es conforme con la Directiva 2014/53/UE. El texto completo de la declaración UE de conformidad está disponible en la dirección Internet siguiente: [www.yalelock.com/smart-living/doc](http://www.yalelock.com/smart-living/doc)



**THE YALE BRAND**, with its unparalleled global reach and range of products, reassures more people in more countries than any other consumer locking solution.

**THE ASSA ABLOY GROUP** is the world's leading manufacturer and supplier of locking solutions, dedicated to satisfying end-user needs for security, safety and convenience.