

Schnitt A-A

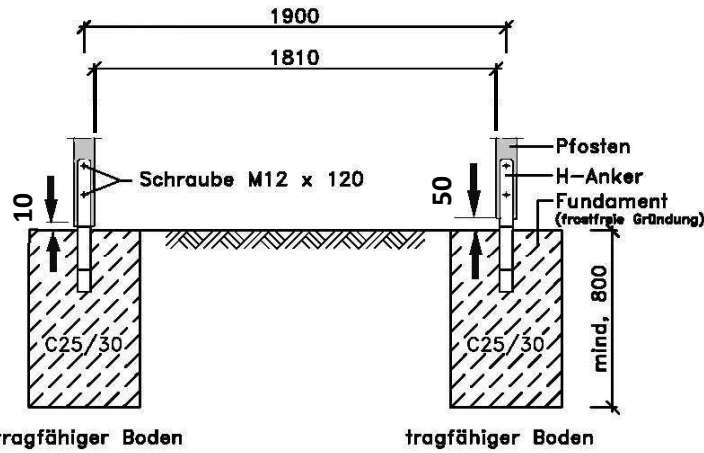

Frontwand ←

Grundriss

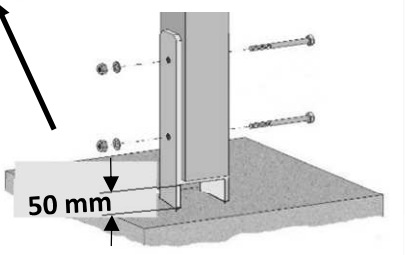
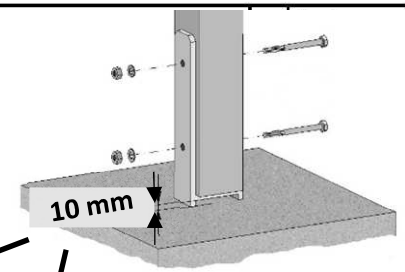
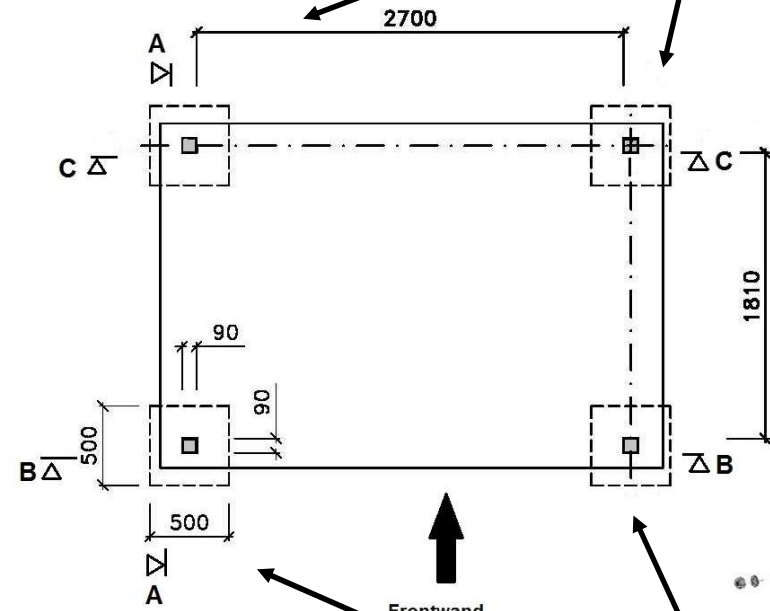

Schnitt B-B

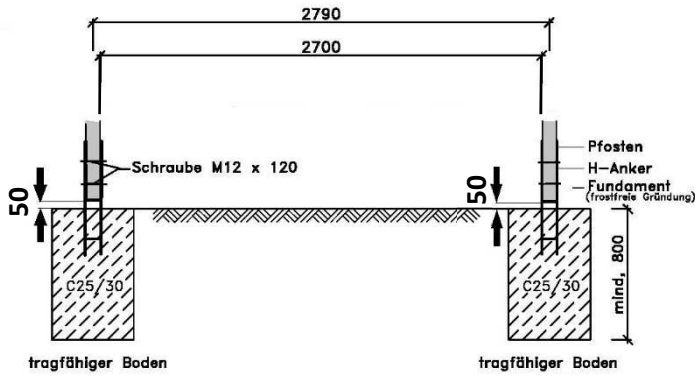

Schnitt C-C

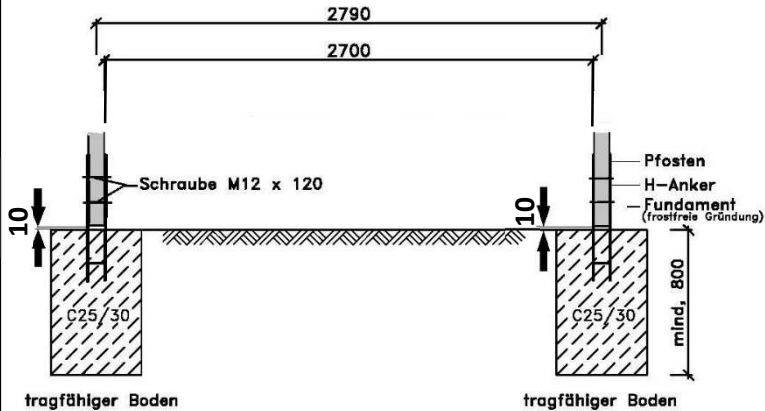

Technische Änderungen vorbehalten!

Copyright weka-Holzbau GmbH Neubrandenburg

Stand:15.01.2018

	Datum	Unterschrift	Zeichnungsnummer	
Gezeichnet	15.01.2018	Schott		
Geändert				
Blatt-Nr.:	<p style="text-align: center;"><b>Fundamentplan 607.0601.20.00</b></p>			
Blatt-Nr.:				