



T1

Bitte unbedingt ausfüllen!

Name

Strasse

Plz

Ort

Tel.

T2

Sehr geehrte Kunden,

wir freuen uns, dass Sie sich für ein Produkt aus dem Hause Pelipal entschieden haben. Sollte es trotz aller Bemühungen unsererseits, Ihnen ein qualitativ hochwertiges Möbelstück zu liefern, zu Fehlteilen kommen, schicken Sie bitte dieses ausgefüllte Blatt an

Fax.: **+49 3443/434354**

E-Mail: **ersatzteile@pelipal.de**

Bitte beachten Sie, dass Bauteile über 800mm Länge und 350mm Breite direkt bei Ihrem Möbelhändler zu beanstanden sind. Zur Reklamationsbearbeitung ist es unbedingt erforderlich **die Artikelnummer des Schrankes**, welche auf dem Etikett ersichtlich ist und den Markt, wo das Möbel erworben wurde anzugeben. Außerdem tragen Sie unten bitte die benötigte Stückzahl ein. Viel Spaß mit Ihrem neuen Badmöbel! Ihr Pelipal Team

_____ - _____

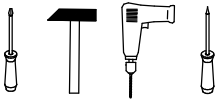

T3

Für den Zusammenbau sind 2 Personen erforderlich.

T4

Montage-Richtzeit 3 Stunden

12 x a DUEB-SMD-000005	Stück	12 x b EXZENTER-000015	Stück	5 x d ZPL-003X004	Stück	1 x f 1 x g 			
5 x e TBD-35-115X00	Stück	1 x j AUF-001-000080	Stück	1 x k AUF-001-000090	Stück	1 x h 			
18 x l SCH-SPA-035X015	Stück	4 x m 6,3 x 11 SCH-KA-063X011	Stück	15 x n 1,4 x 25 NAGEL-025X001	Stück	1 x i 			
4 x o 5 x 8 ADK-AL1-005X008	Stück	3 x p Griff	Stück	6 x q SCH-RDK-040X015	Stück	KA-SZ-270X150			Stück
10 x r SCH-RDK-035X015	Stück	2 x s AUF-001-000020	Stück	12 x t TRAE-001-000020	Stück	2 x v TUER-DAEM-000010		2 x w TUER-ADA-000010	Stück
1 x x VBD-000020	Stück	1 x y 4,5 x 45 SCH-RDK-045X045	Stück	1 x z 4,0 x 15 SCH-RDK-040X015	Stück				

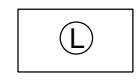
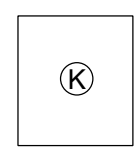
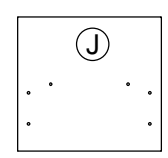
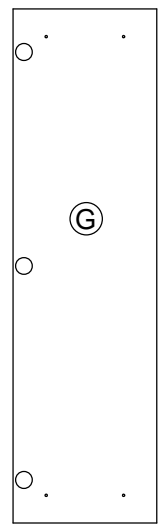
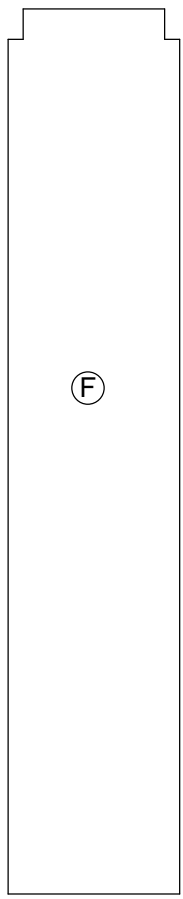
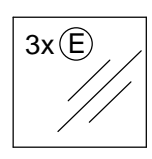
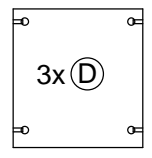
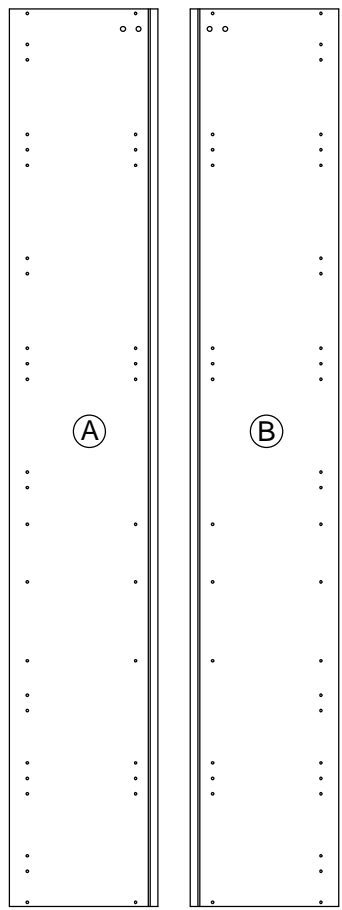

1.

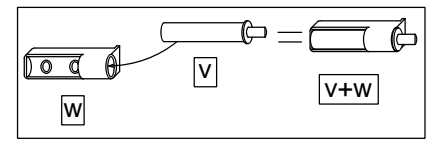
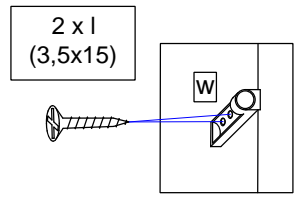
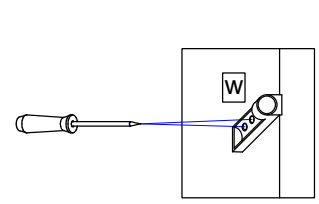
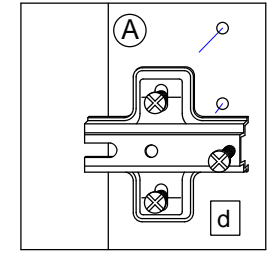
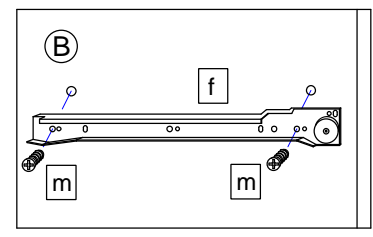
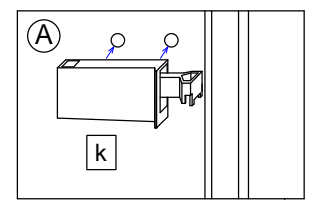
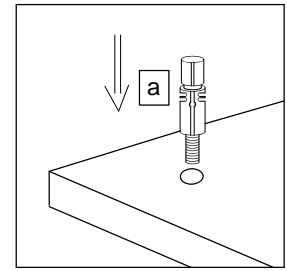
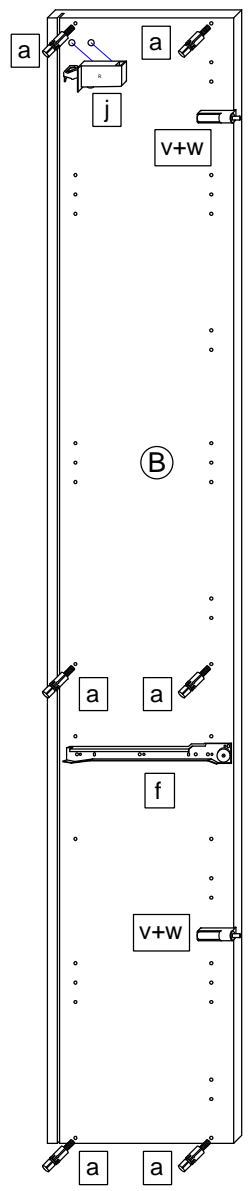
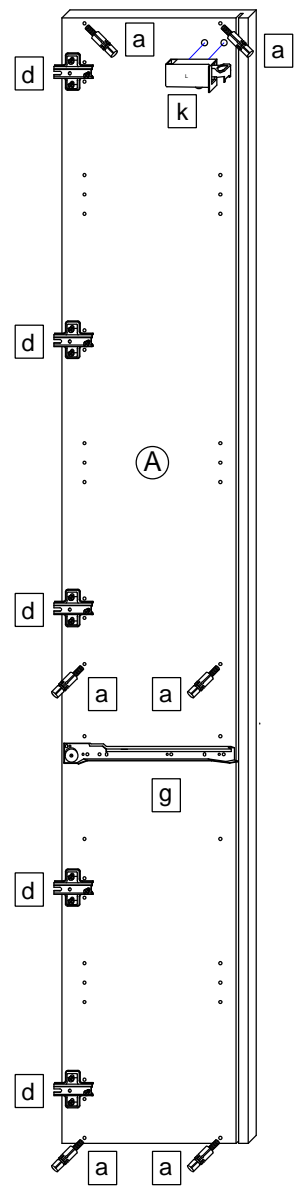
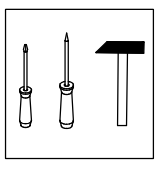

2.

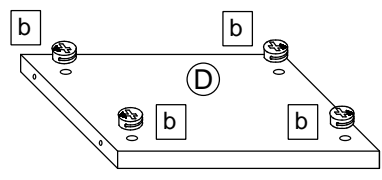
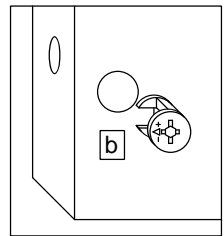
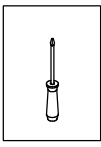

3.

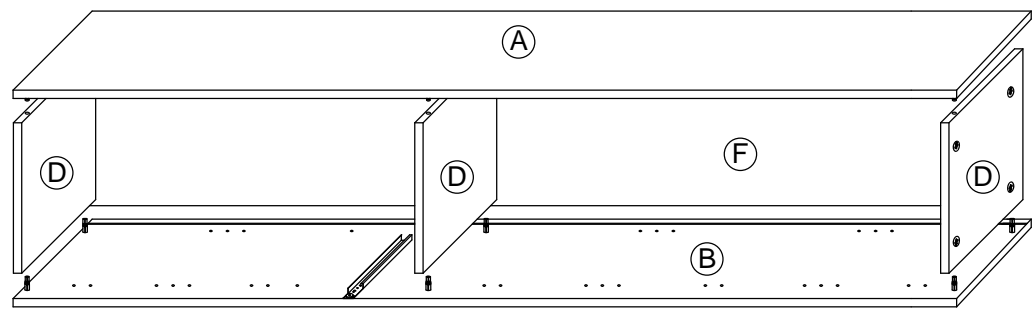
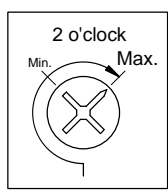
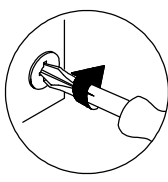
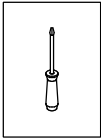

4.

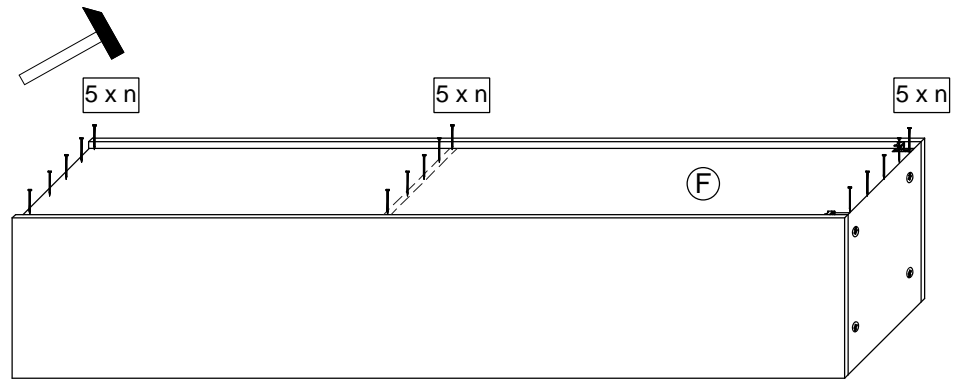
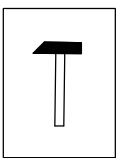

5.

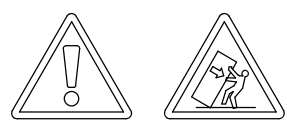
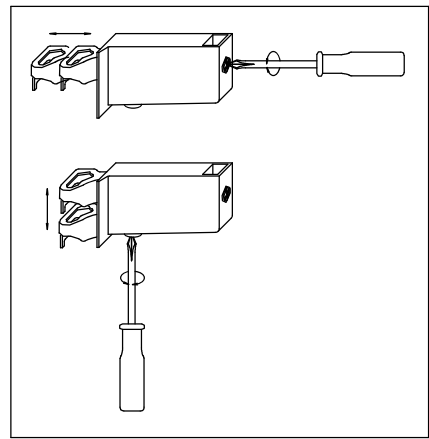
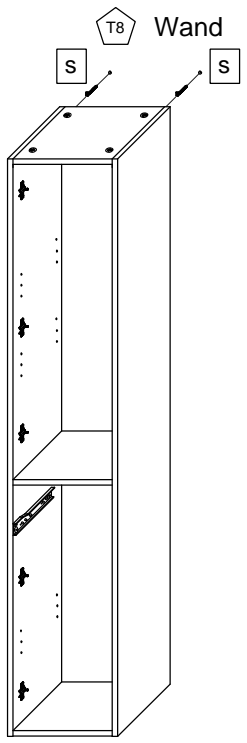
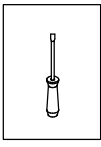

T9 Lassen Sie den Schrank nur durch fachkundige Personen mit für die Wand geeignetem Montagematerialien montieren.

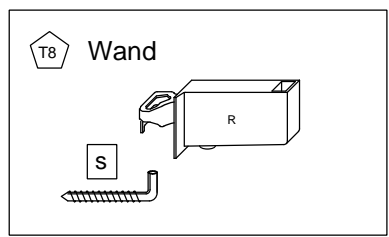

6.

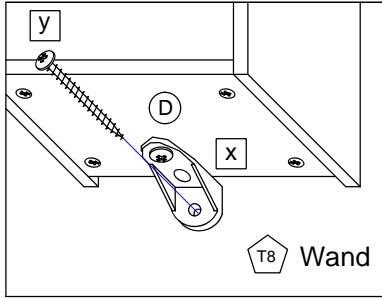
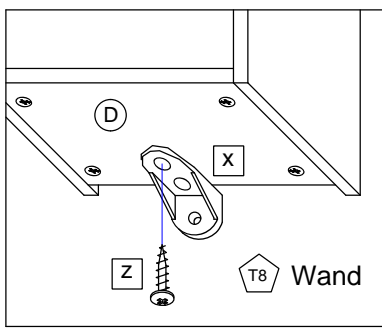
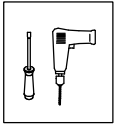

7.

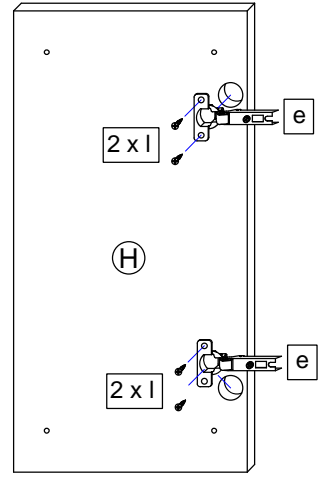
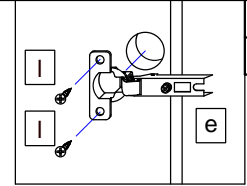
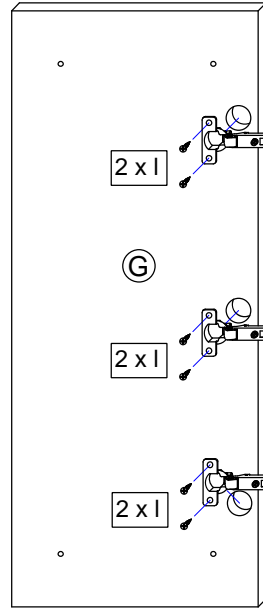
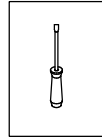

8.

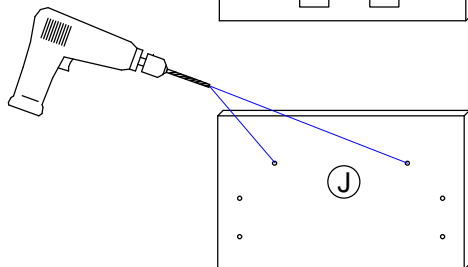
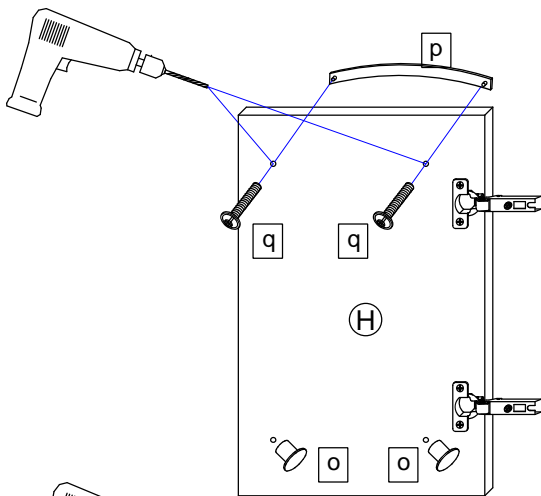
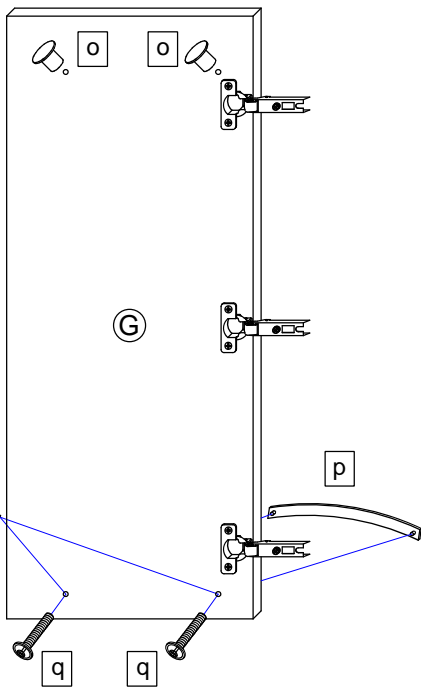
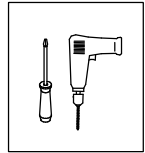

8.1

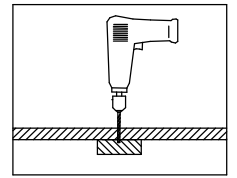
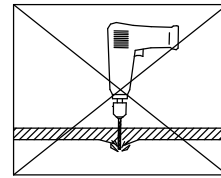

8.2

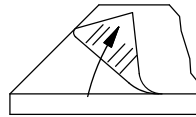

Bei Hochglanz-Fronten bitte erst die Schutzfolie entfernen und dann den Griff montieren!

8.3

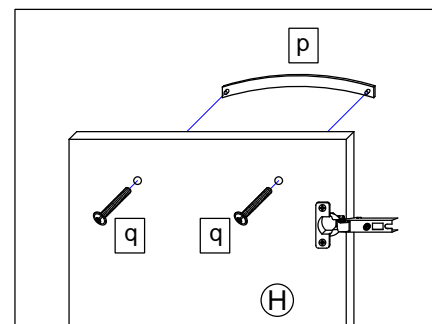
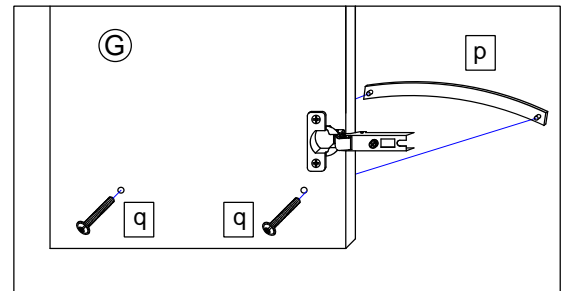

9.

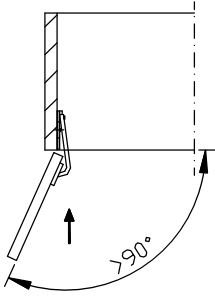
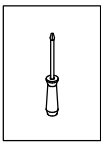

T11 Bei Türmontage das Scharnier einhängen, bis Anschlag öffnen und anschließend festschrauben.

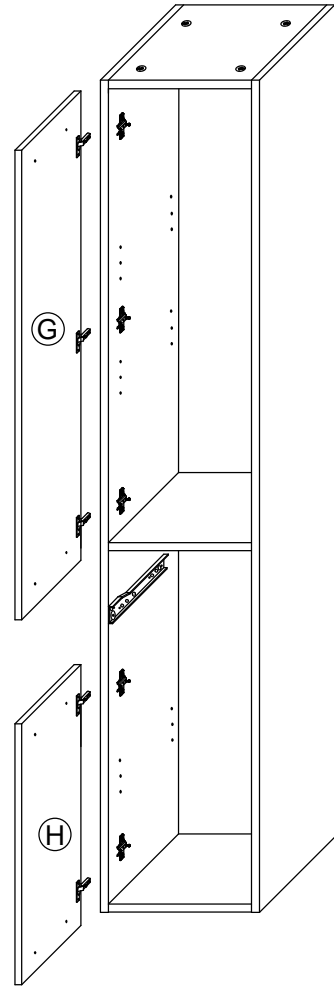
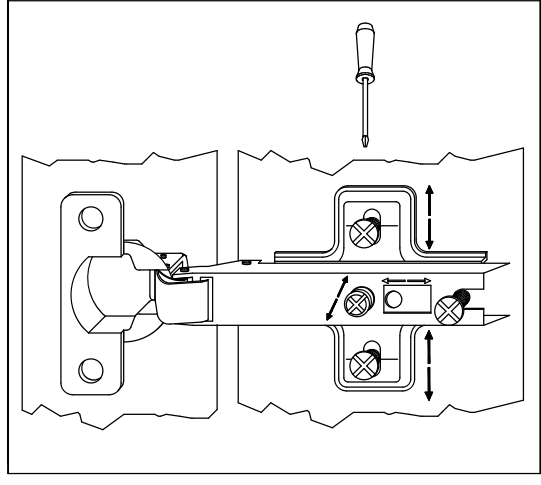

10.

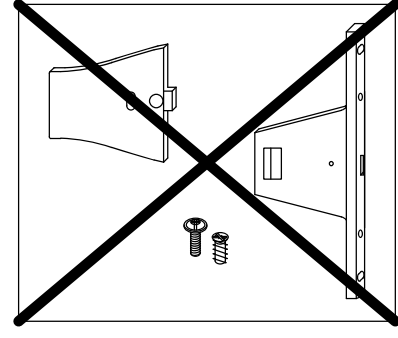
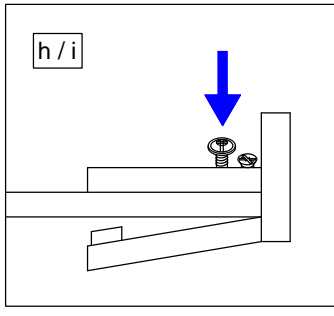
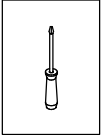

10.1

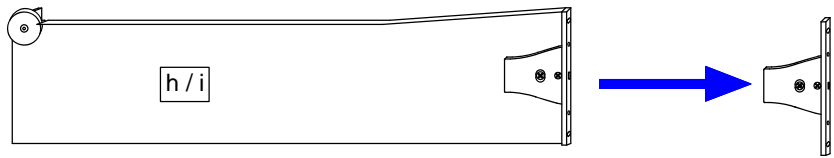

10.2

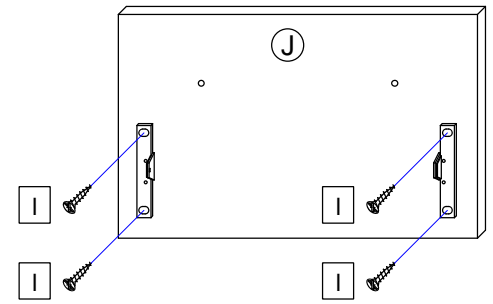

T5 Das Etikett, welches sich unten rechts befindet bitte ausschneiden und auf der Rückwand mit Klebeband (nicht beiliegend) befestigen.

PELIPAL GmbH
Hans-Wilhelm-Peters-Straße 2
33189 Schlangen
Germany

11.

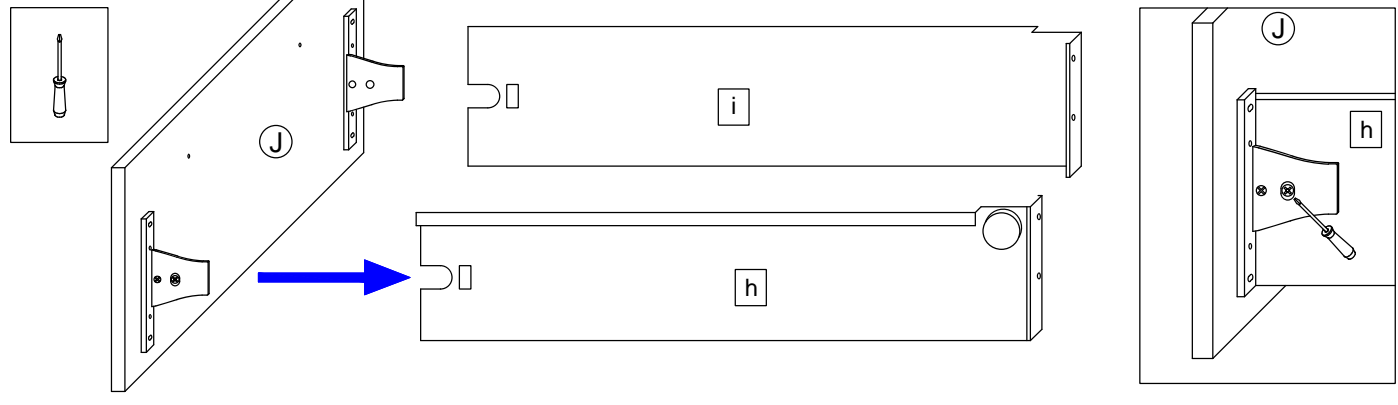

12.

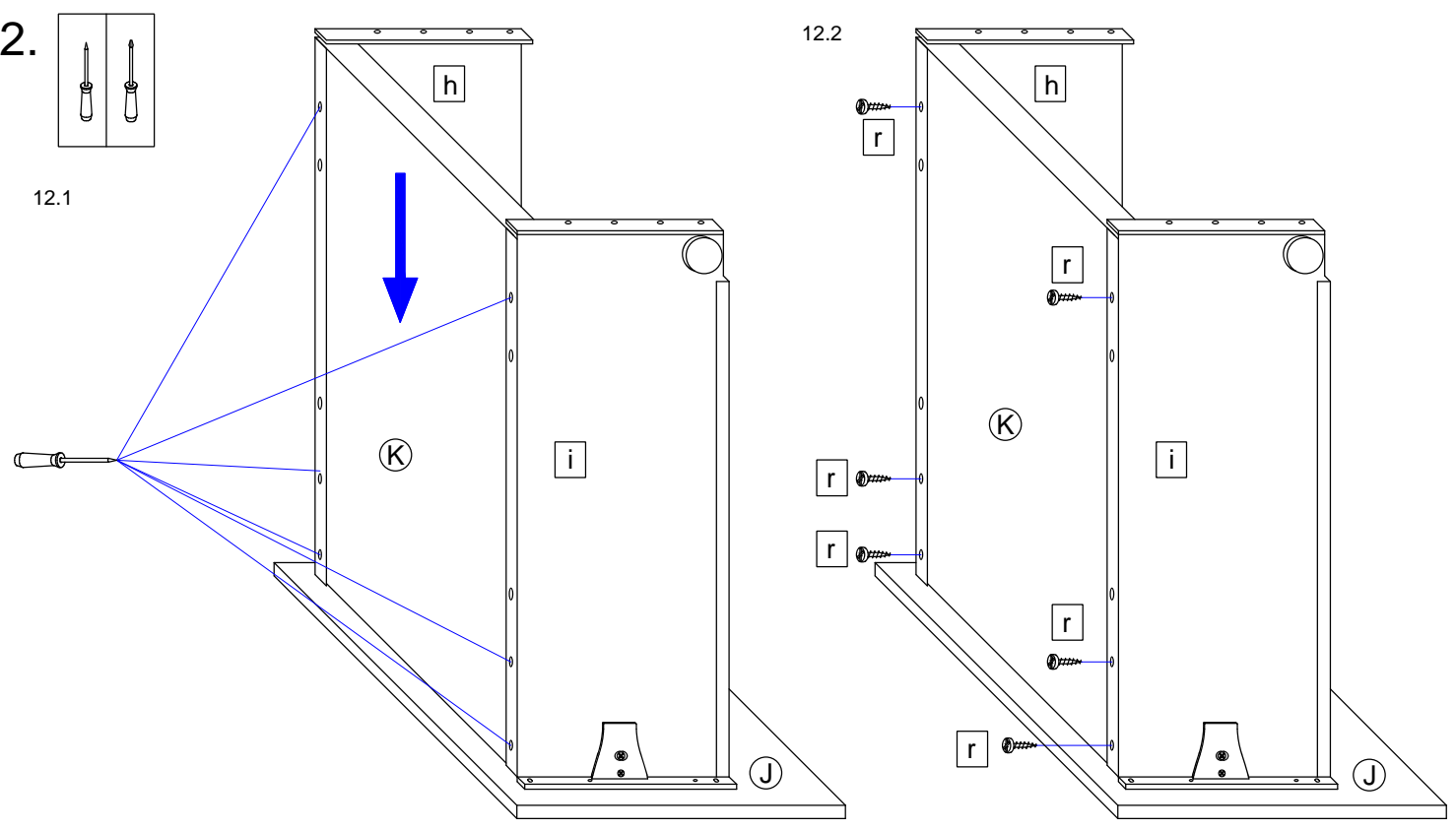

13.

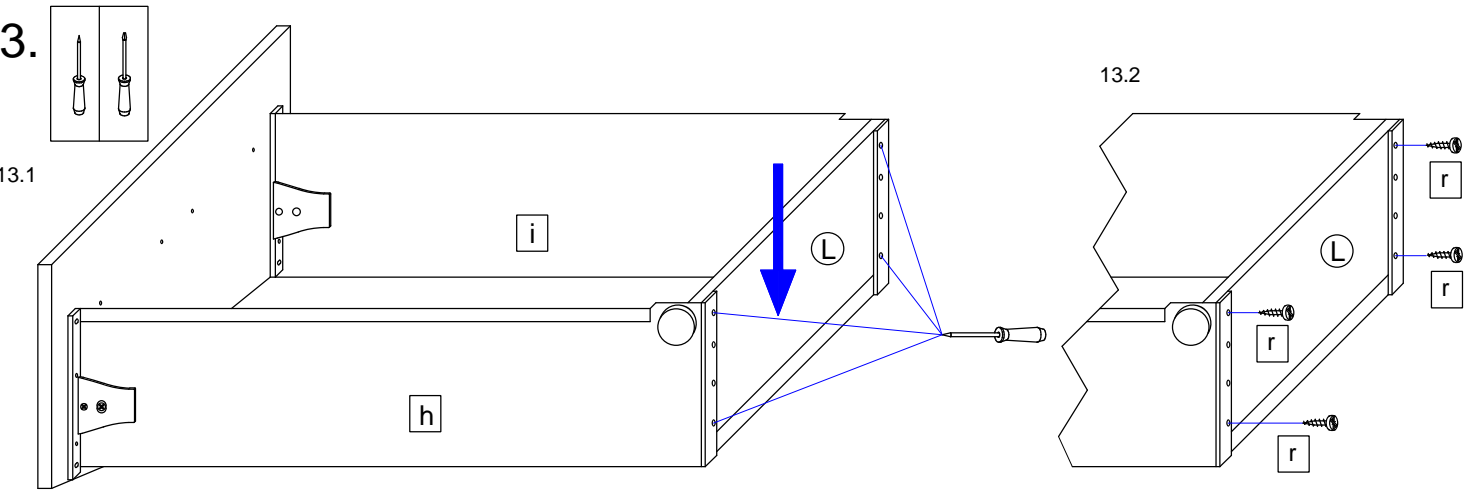

14.

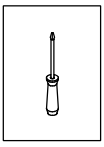

14.1

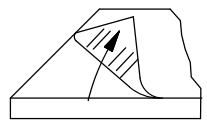

Bei Hochglanz-Fronten bitte erst die Schutzfolie entfernen und dann den Griff montieren!

14.2

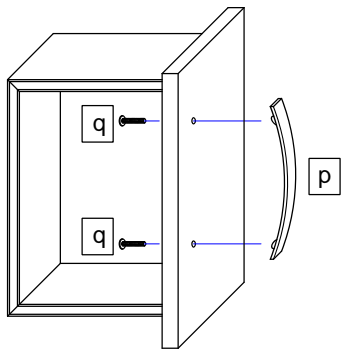

15.

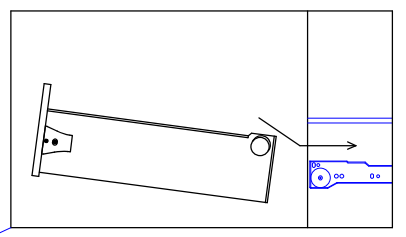
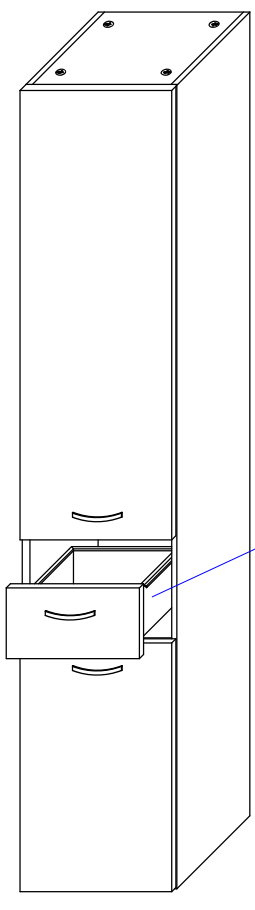

16.

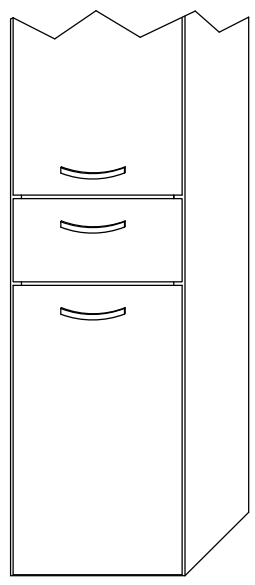
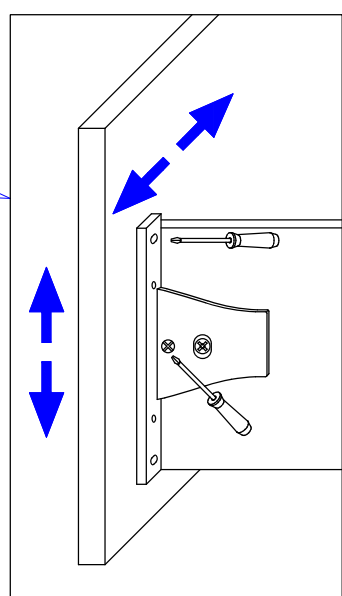
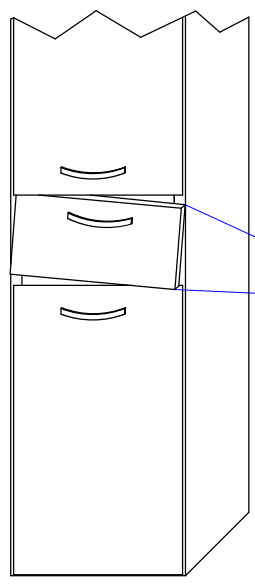
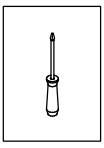

17.

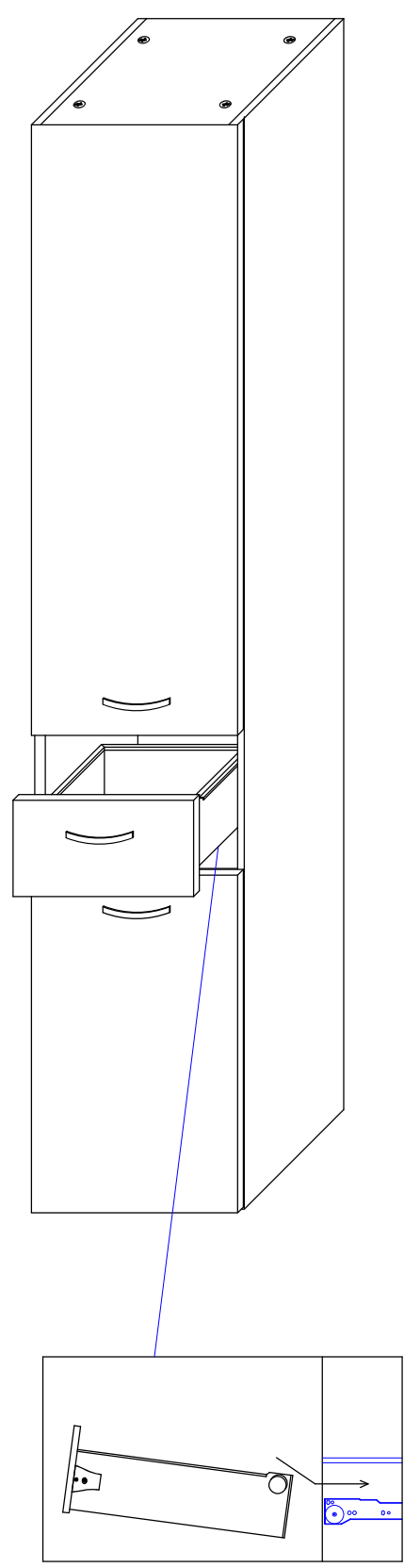

18.

