

2. PARTS DESCRIPTION

2.1 BOX CONTENT | INHALT | CONTENUS | INHOUD DOOS | CONTENUTO | CONTENIDO DE LA CAJA

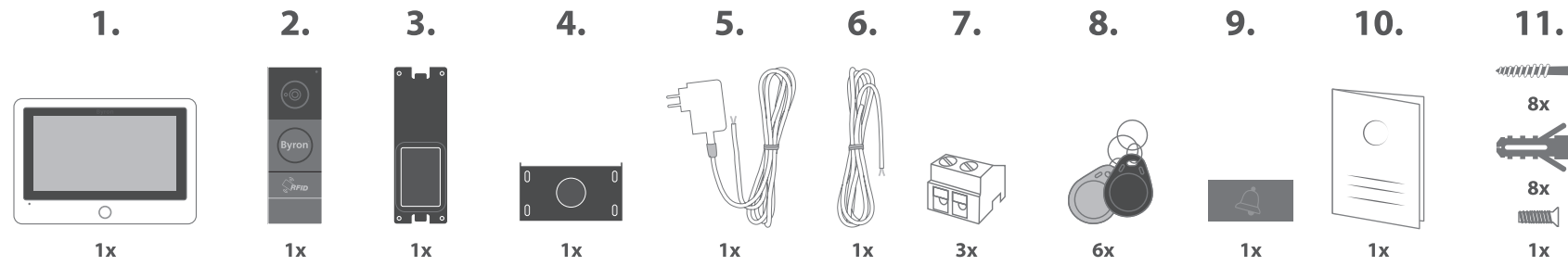

2.2 MONITOR

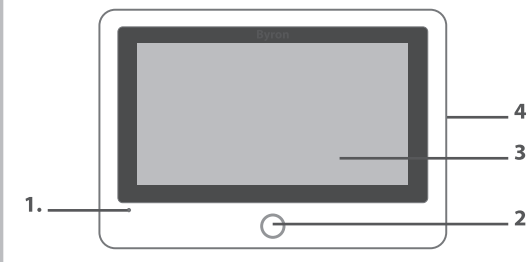

2.3 OUTDOOR UNIT (DOORBELL)

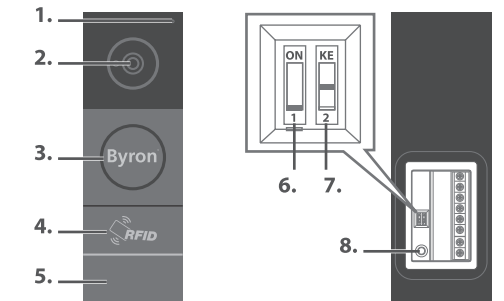

3. INSTALLATION

3.1 MOUNTING THE MONITOR

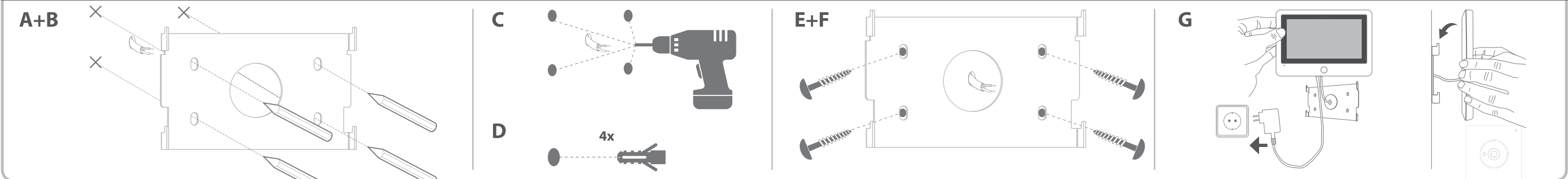

3.2 MOUNTING THE OUTDOOR UNIT (DOORBELL)

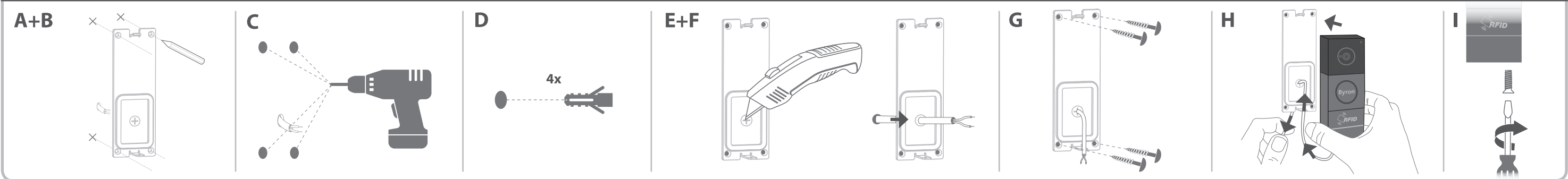

3.3 ELECTRICAL INSTALLATION

3.3.1 CONNECTING THE TERMINAL BLOCKS (MONITOR AND OUTDOOR UNIT)

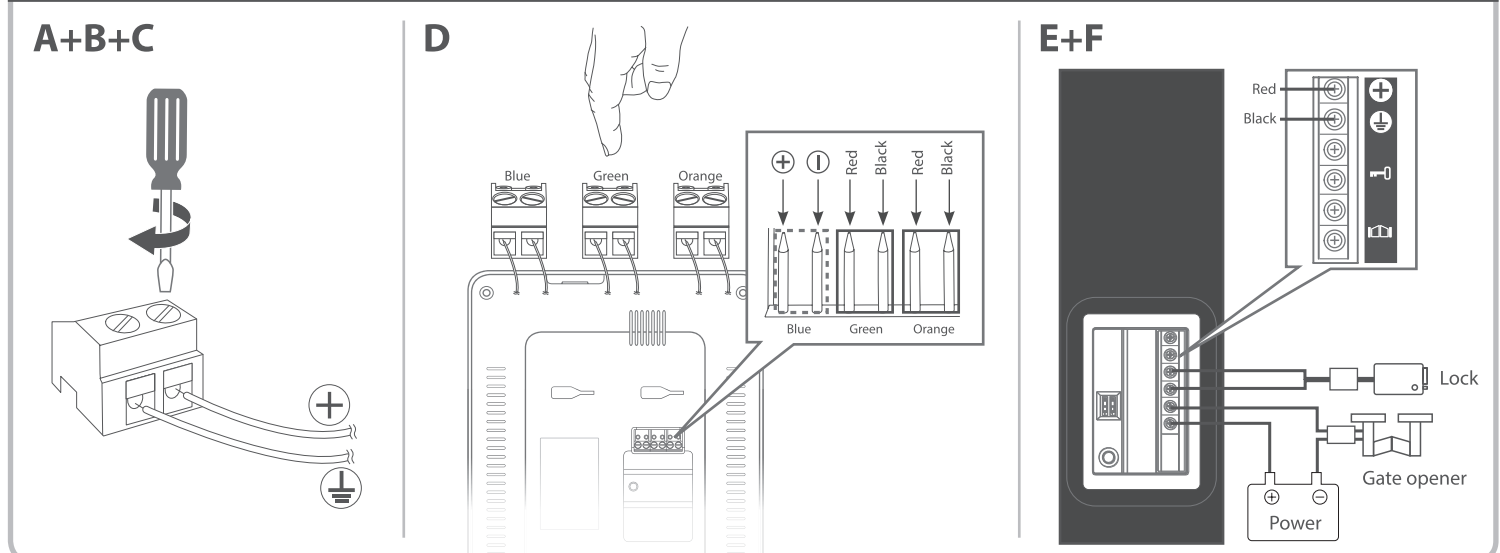
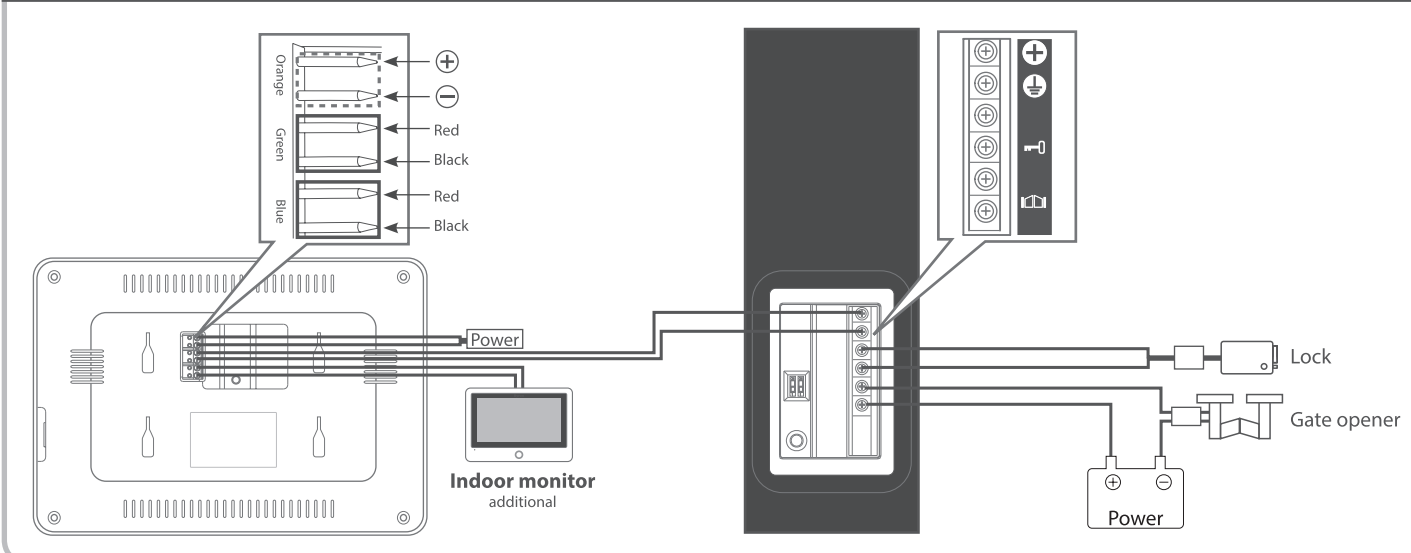

3.3.2 CONNECTING AN ADDITIONAL MONITOR

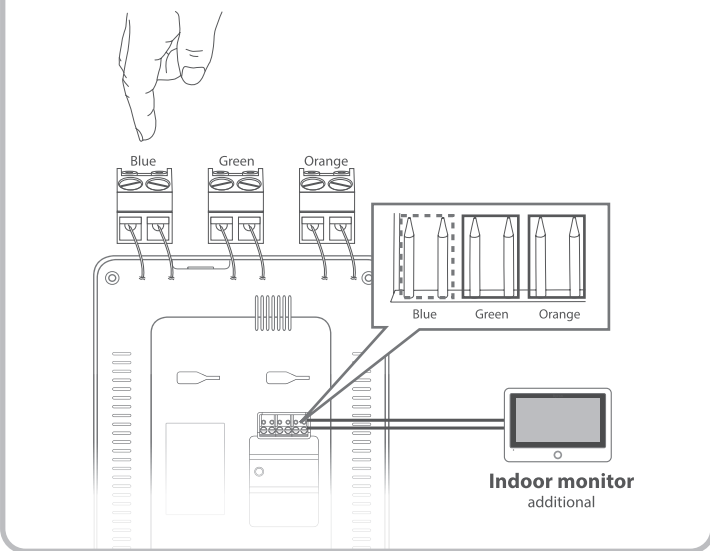

3.3.3 CONNECTING THE AC POWER

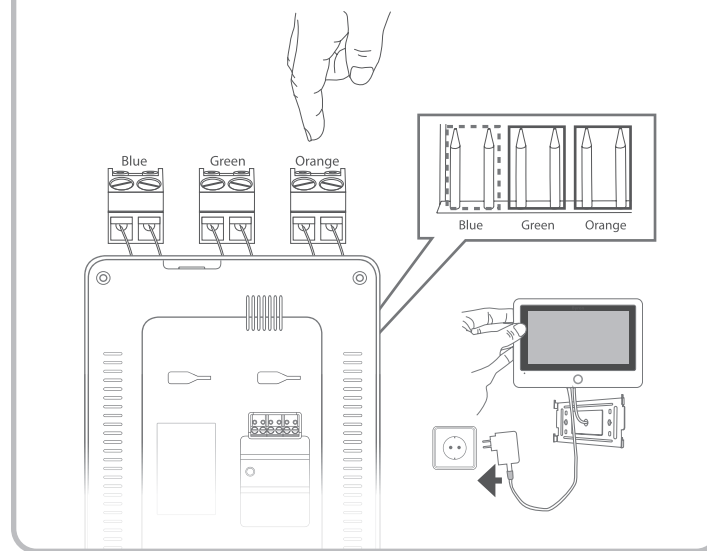

3.3.4 CONNECTING A DOOR LOCK (NOT INCLUDED) | 3.3.5 CONNECTING A GATE OPENER (NOT INCLUDED)

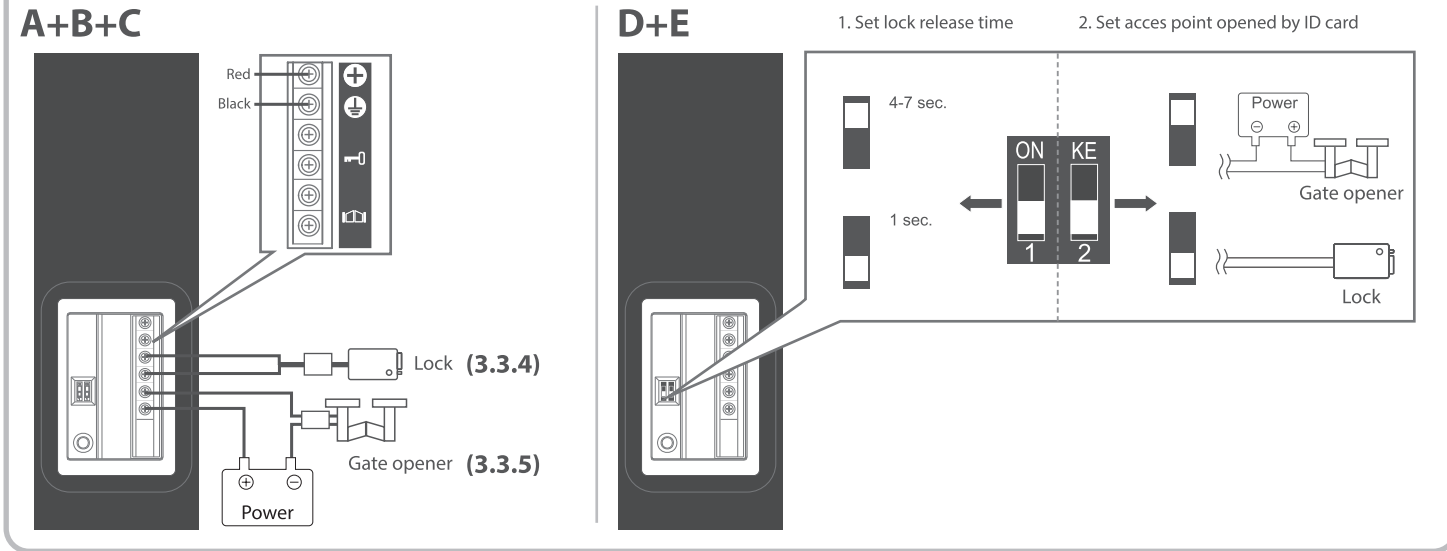

4. REPLACE CALL BUTTON

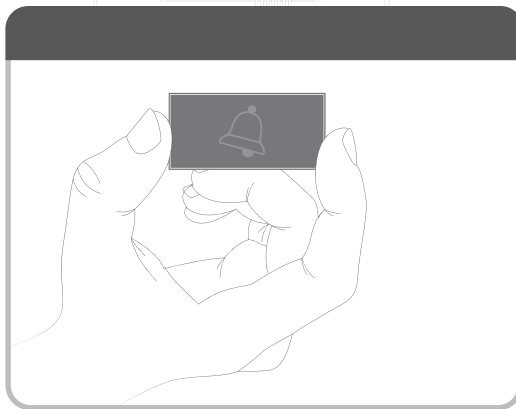

5. BASIC FUNCTIONS

5.1 UNLOCKING YOUR DOOR OR GATE

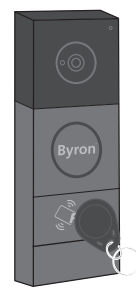

5.2 ANSWERING A CALL

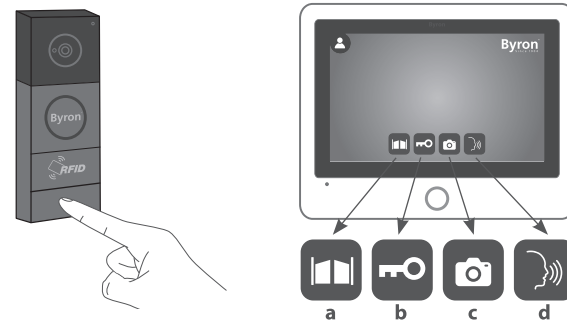

5.3.1 REGISTERING AN ADMINISTRATOR TAG



5.3.2 REGISTERING A USER TAG (MAX. 50)

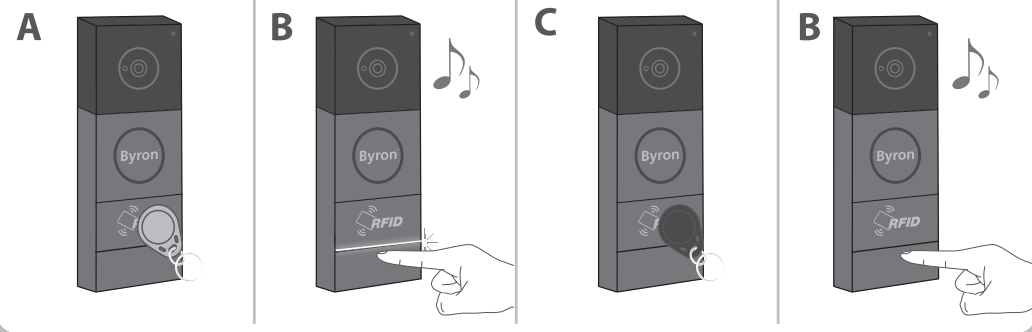

5.4 CANCELLING A RFID TAG

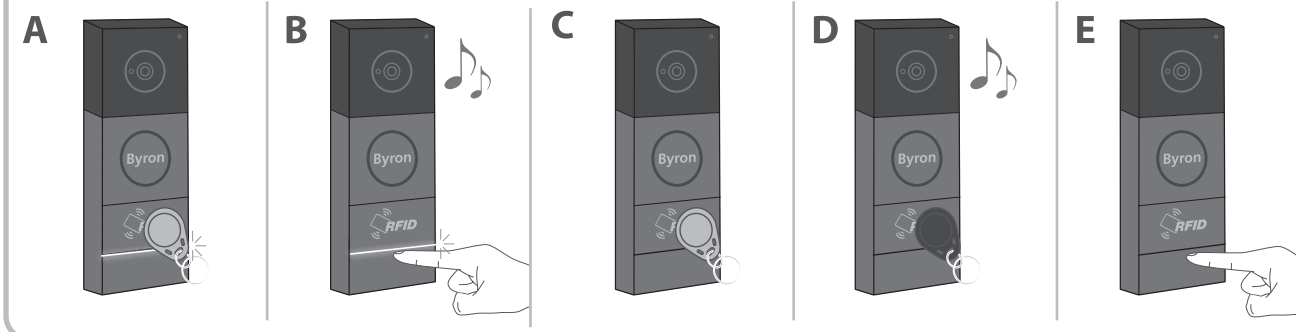

5.5 CANCELING ALL RFID TAGS

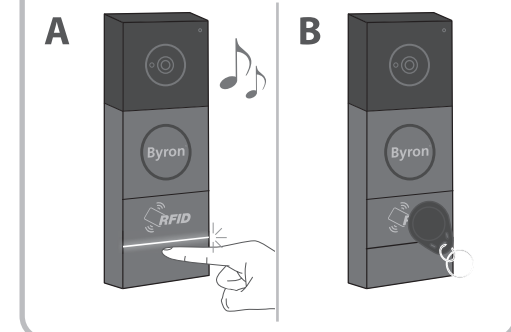

6. HOME SCREEN AND MENUS

