

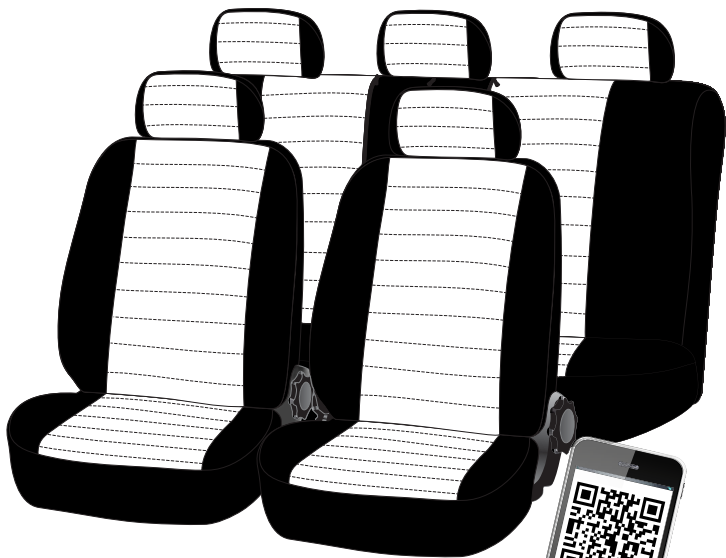

**WALSER**



## **BASIC & PREMIUM ZIPP-IT SET**

**MONTAGEANLEITUNG  
MOUNTING INSTRUCTION  
INSTRUCTIONS DE MONTAGE**



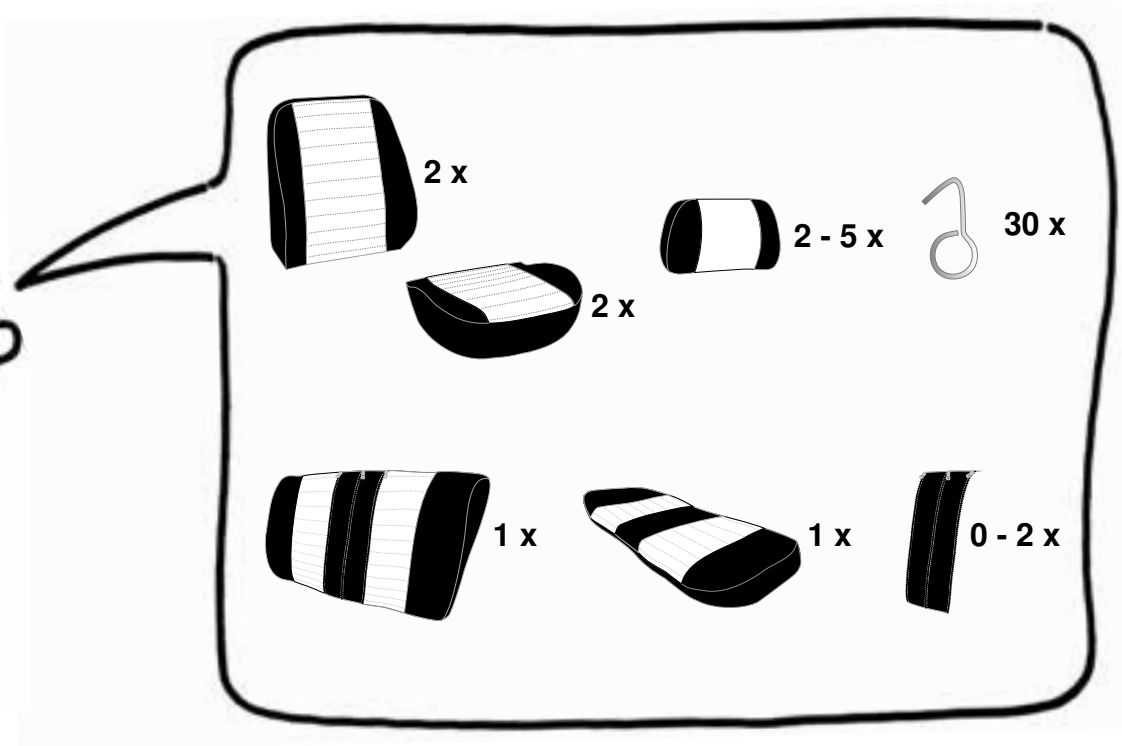

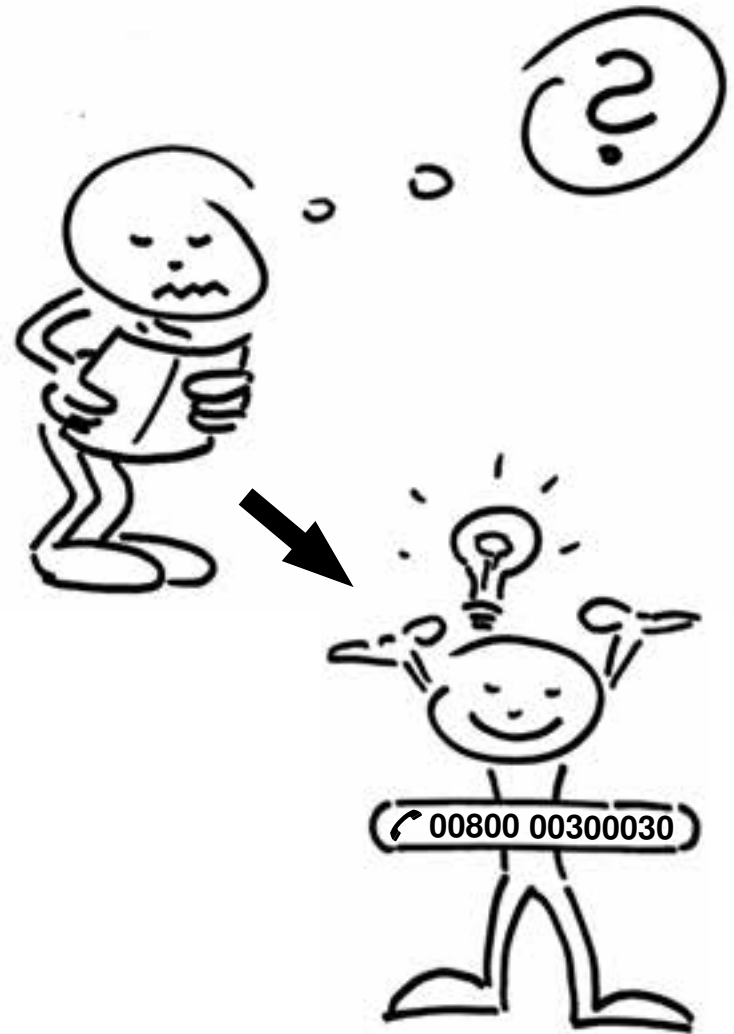

## OPTION 1

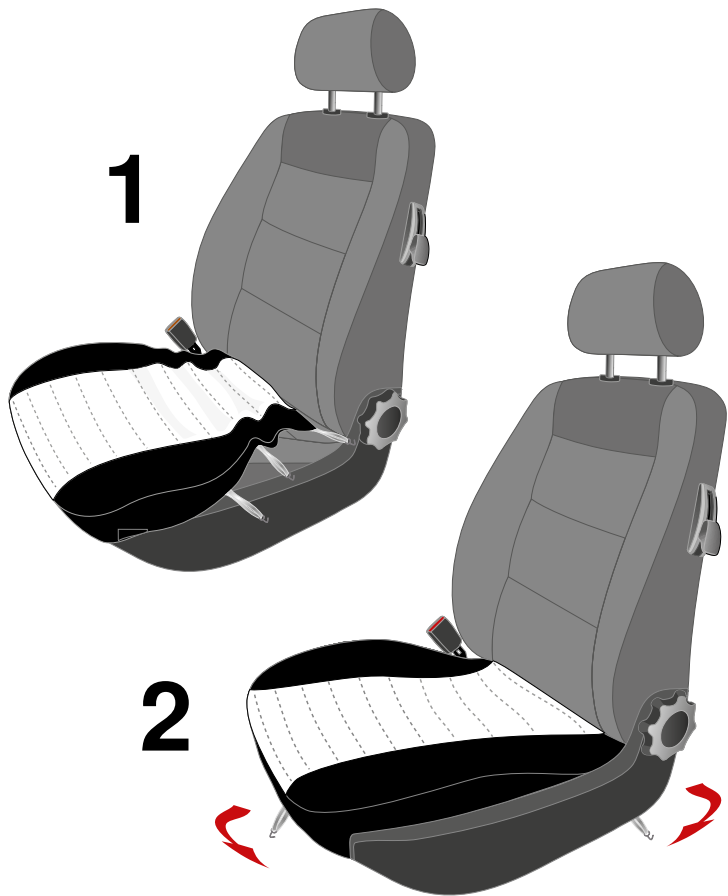

## OPTION 2

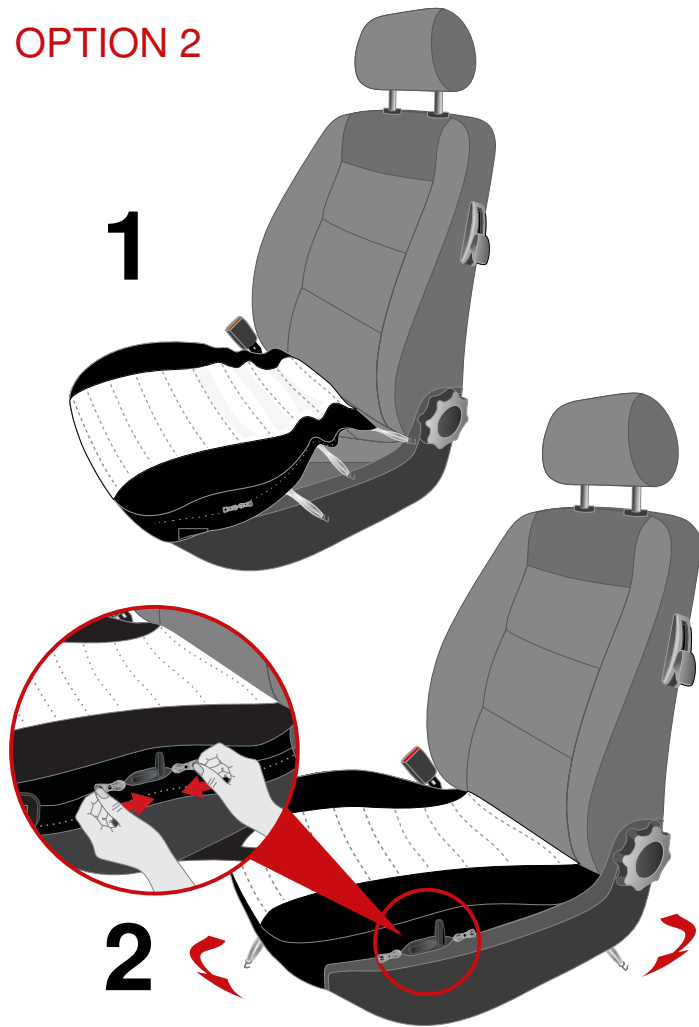

# OPTION 3

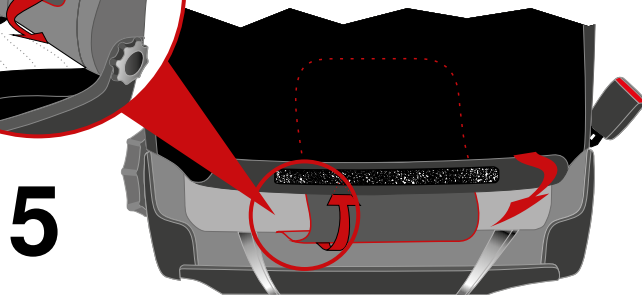
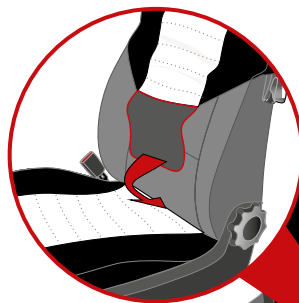
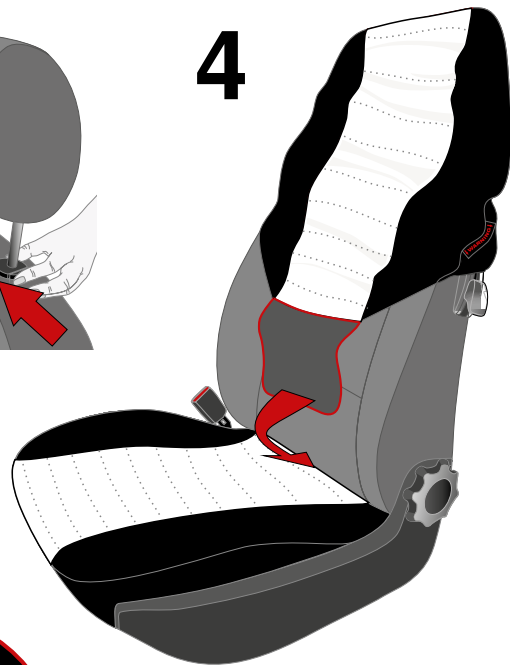
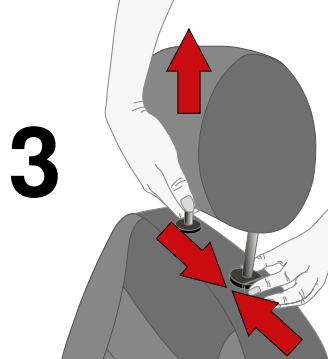
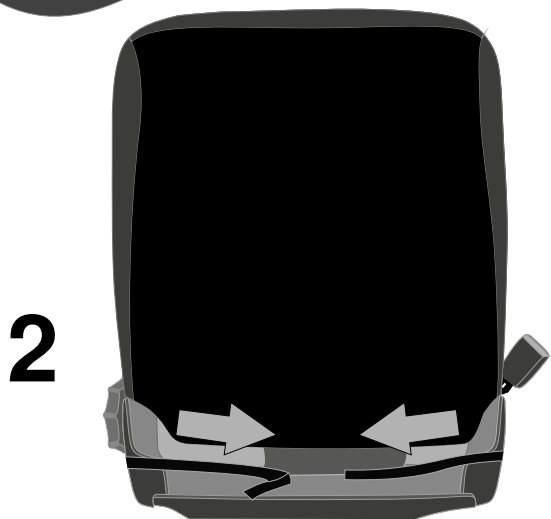

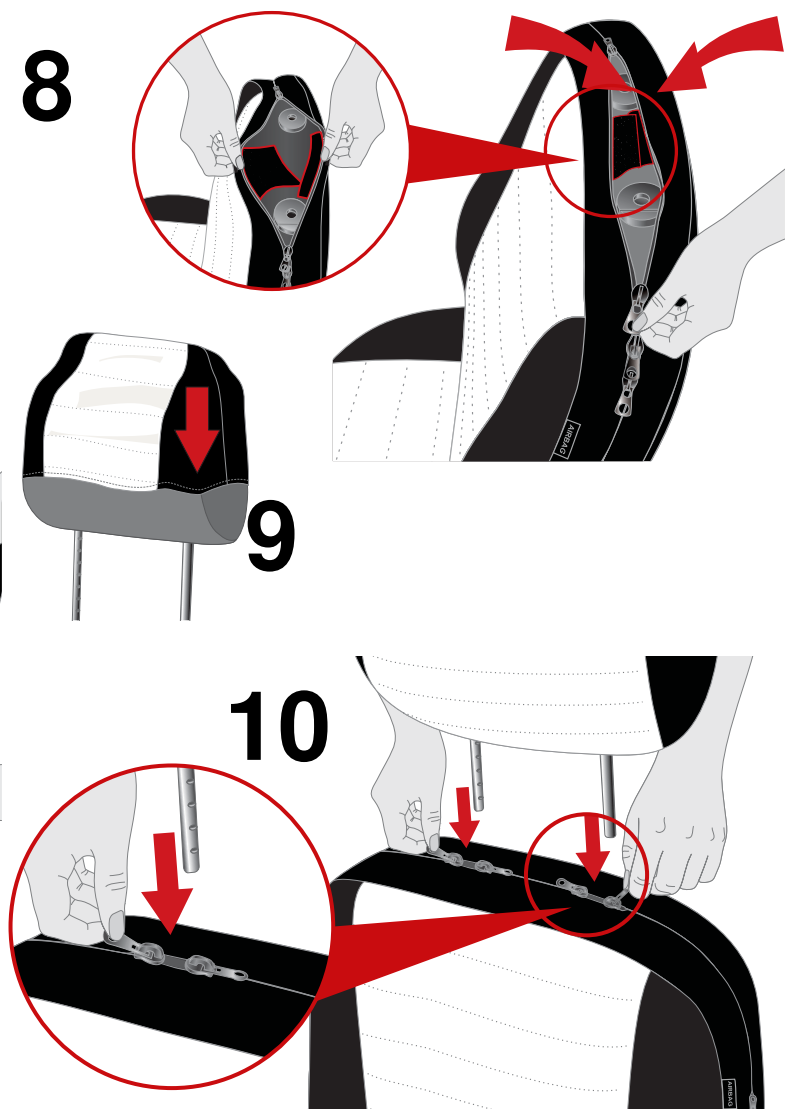
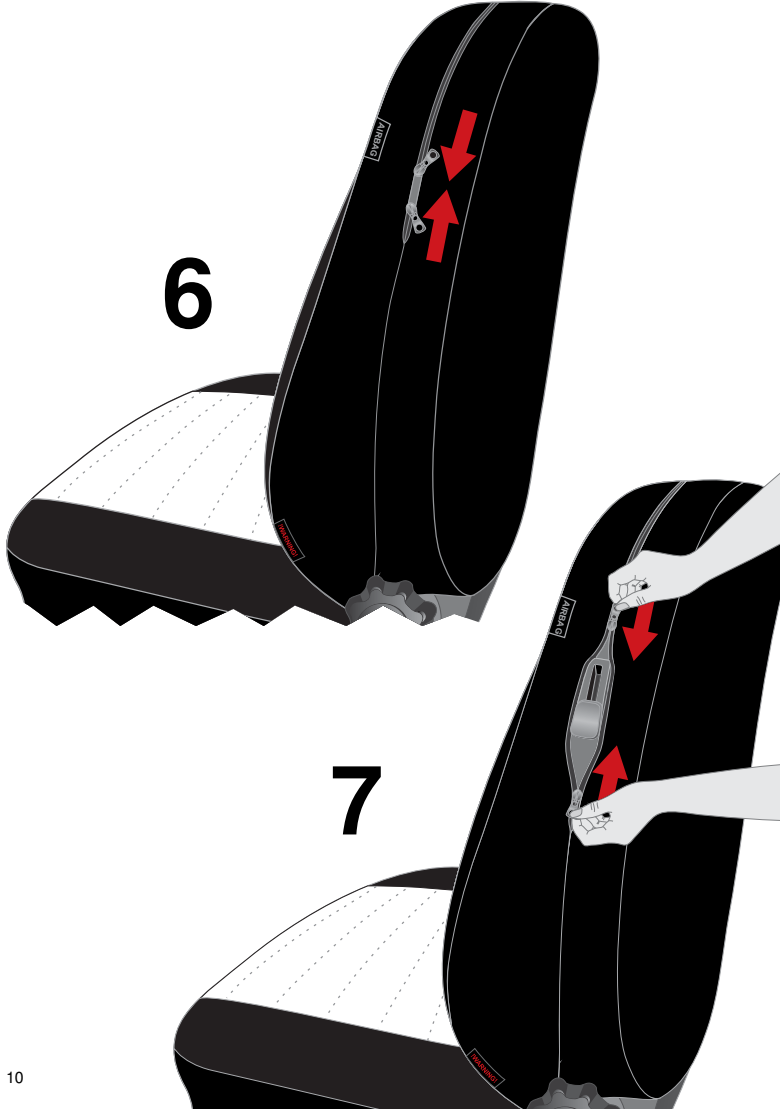

# 11

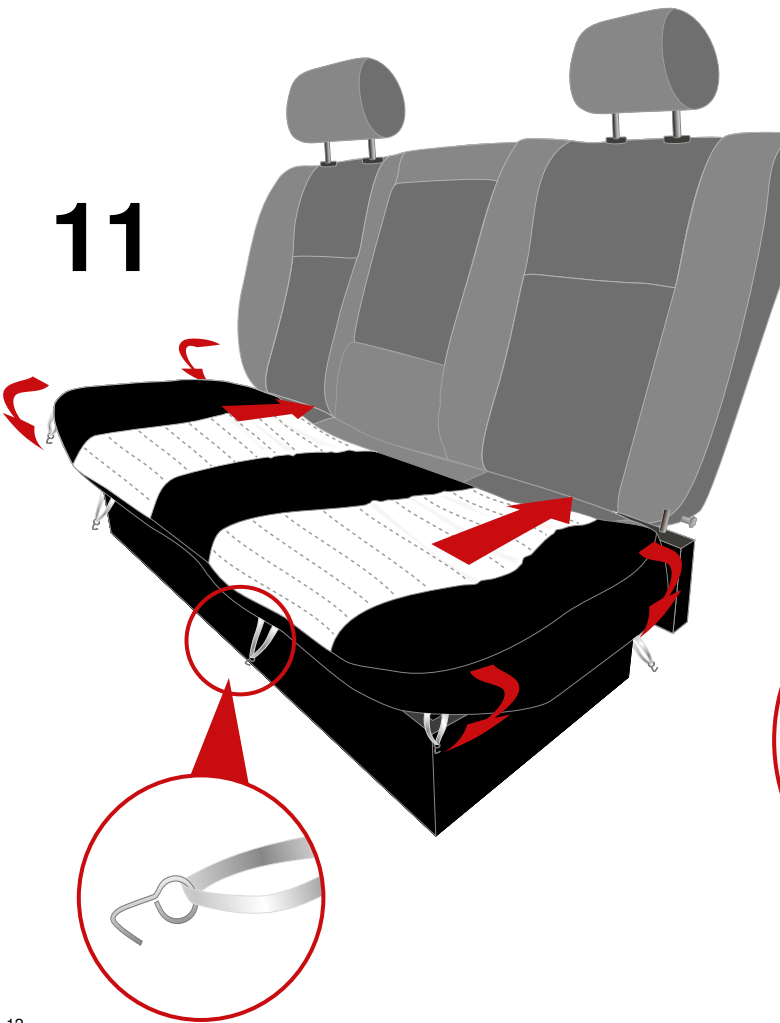

# 12

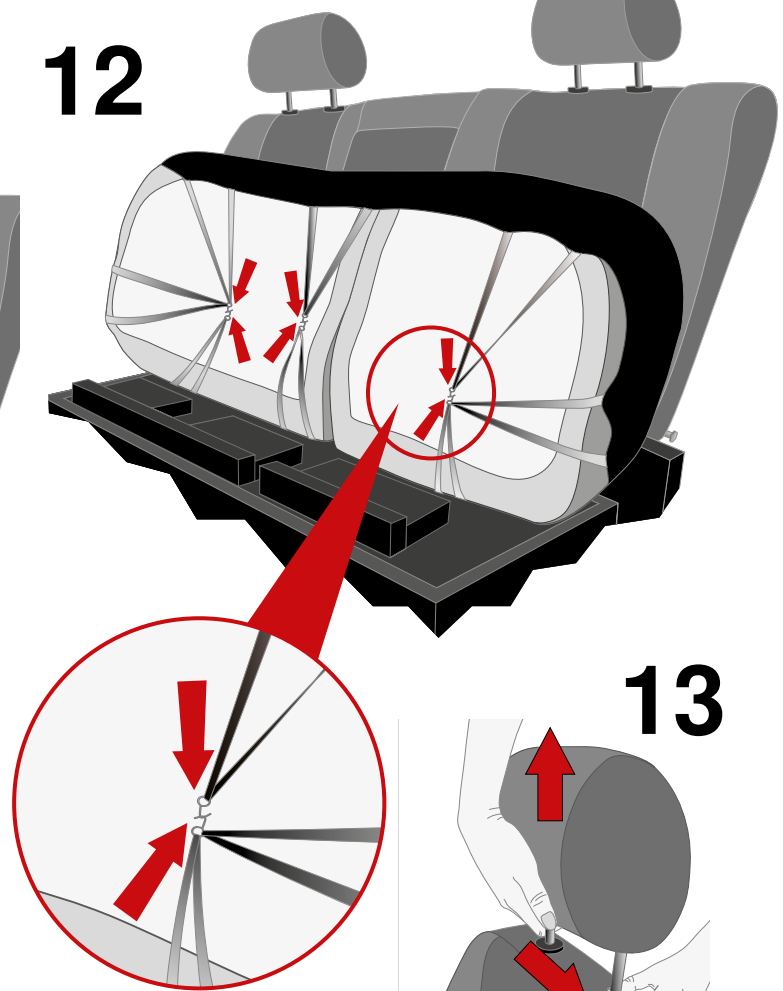

# 13

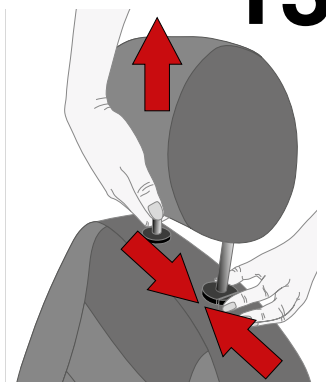

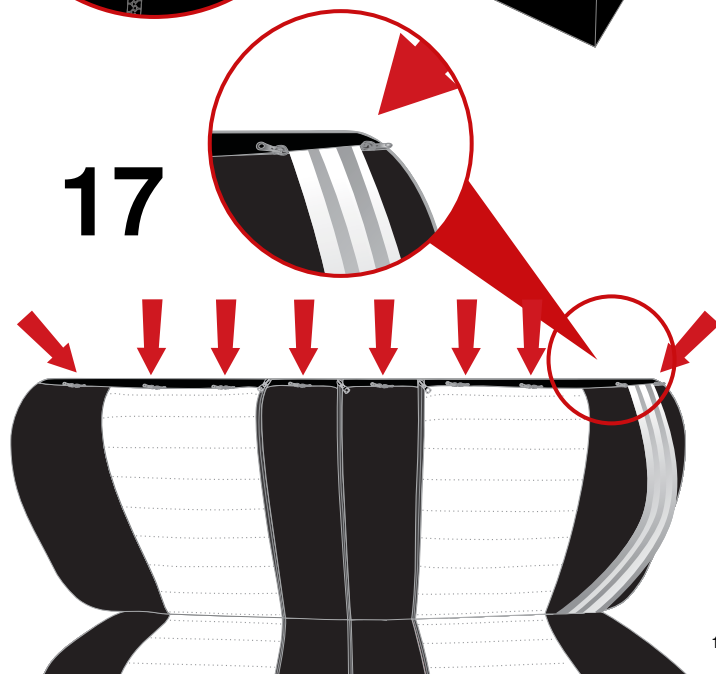
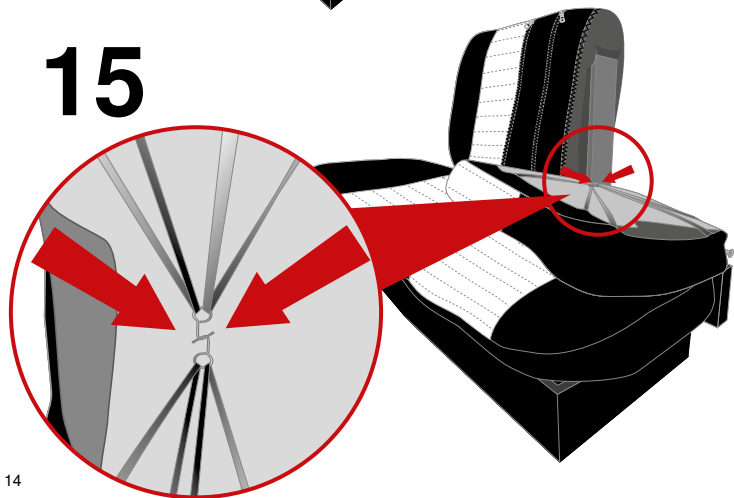
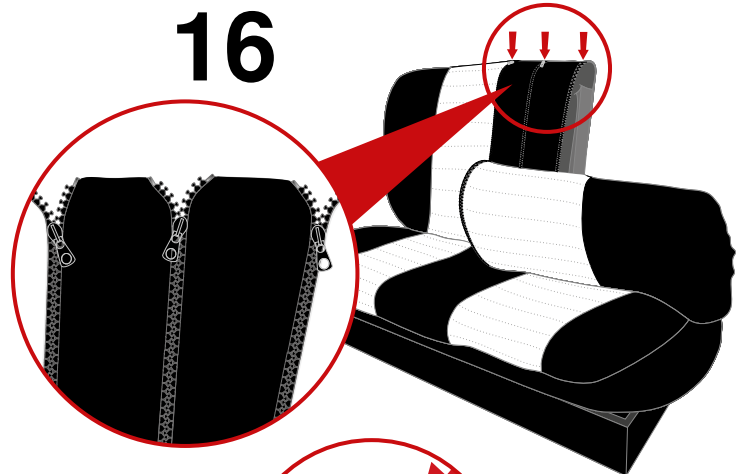
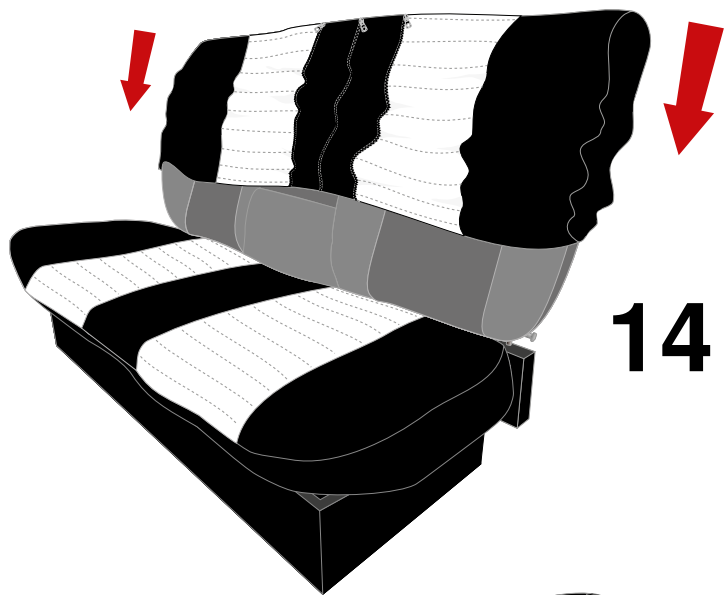



# 18

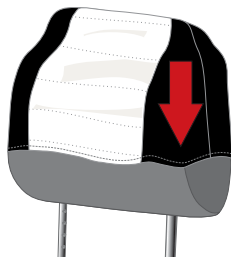

# 3x

# 19

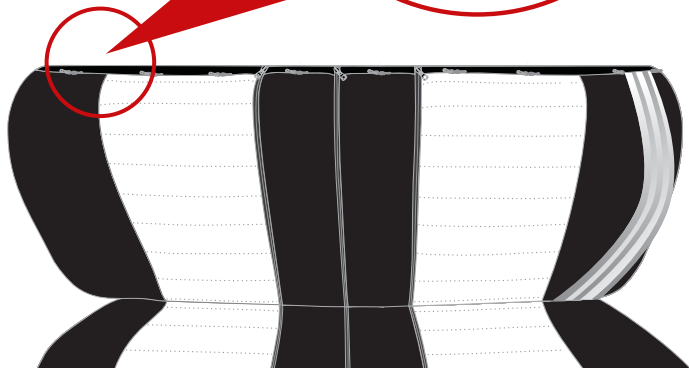
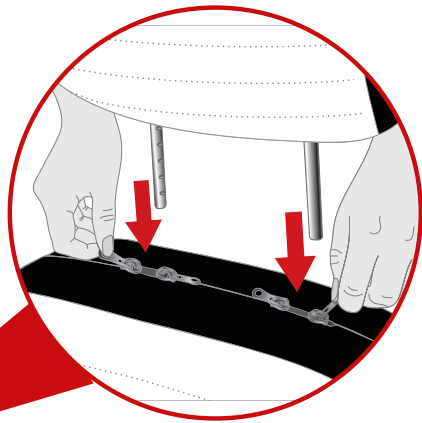

DE



## WICHTIG



### Sicherheitshinweise

Montage ausschließlich in Personenkraftwagen laut Typenliste auf Verpackung oder beiliegender, detaillierter Clix-Broschüre gestattet.

Vorsicht - Bei nicht ordnungsgemäßer Montage kann das richtige Austreten des Sitzairbags im Falle eines Aufpralls nicht gewährleistet werden.

Die Verpackung von Kleinkindern fernhalten - Erststickungsgefahr!

EN



## IMPORTANT



### Safety informations

May only be installed in the motor cars listed on the packaging or the enclosed detailed Clix brochure.

Caution: Incorrect fitting can prevent the seat airbag from inflating correctly in the event of a collision.

Keep the bags away from small children – danger of suffocation.

FR



## IMPORTANT



### Remarques concernant la sécurité

Montage exclusivement dans les voitures légères en fonction de la liste de véhicules figurant sur l'emballage ou de la brochure Clix détaillée jointe.

Attention - Si le montage n'est pas conforme, la sortie correcte de l'airbag de siège ne peut pas être garantie en cas de collision.

Conserver l'emballage hors de portée des jeunes enfants – risque d'étouffement !

IT



## IMPORTANTE



### Note di sicurezza

Montaggio esclusivo in veicoli adibiti al trasporto di persone conformemente all'elenco tipo indicato sulla confezione o alla brochure Clix dettagliata allegata.

Attenzione - In caso di montaggio non corretto non è possibile garantire l'apertura corretta dell'airbag del sedile in caso d'urto.

Tenere lontano dalla portata dei bambini il materiale di imballaggio - Pericolo di asfissia!

ES



**IMPORTANTE**



### **Indicaciones de seguridad**

Está permitida exclusivamente la instalación en turismos, de acuerdo con la lista de modelos del envase o el folleto detallado de Clix adjunto.

Precaución - En caso de que el montaje no sea correcto no se puede garantizar la salida correcta del airbag en caso de choque.

Mantener el envoltorio fuera del alcance de los niños pequeños - ¡Peligro de asfixia!

PT



**IMPORTANTE**



### **Instruções de segurança**

Montagem exclusiva em veículos de passageiros de acordo com a lista de tipos de embalagem ou conforme permitido no folheto detalhado da associação de controlo técnico que vem anexado.

Advertência – A montagem incorrecta pode prejudicar a saída correcta dos airbags em caso de impacto.

Mantem a embalagem fora do alcance de crianças – Perigo de asfixia!

NL



**WICHTIG**



### **Veiligheidsaanwijzingen**

Montage uitsluitend toegestaan in personenauto's volgens de modellenlijst op de verpakking of bijgevoegde, gedetailleerde Clix-brochure.

Voorzichtig – Bij een montage die niet volgens de voorschriften is kan niet worden gegarandeerd dat bij een botsing de airbag naar buiten komt.

De verpakking uit de buurt van kleine kinderen houden – Gevaar voor verstikking!

SE



**VIKTIGT**



### **Säkerhetsanvisning**

Montera endast i personbilar enligt vad som tilläts på typlistan på förpackningen eller förföljande, detaljerade Clix-broschyr.

Försiktighet - Vid felaktig montering kan man inte garantera att airbags fungerar korrekt i händelse av en kollision.

Förvara förpackningen utom räckhåll för barn - kvävningrisk!

FI



**TÄRKEÄÄ**



### **Turvallisuusohjeet**

Istuinpäälliset saa asentaa vain pakkauksen mukana olevassa malliluettelossa tai oheisessa Clix-esitteessä luetteluihin autoihin.

Huomio - Jos istuinsuojuksia ei ole asennettu ohjeiden mukaisesti, istuinturvatyyny eivät ehkä pääse täyttymään oikein onnettomuustilanteessa.

Säilytä pakkaus lasten ulottumattomissa – tukehtumisvaara!

DK



**VIGTIG**



### **Turvallisuusohjeet**

Istuinpäälliset saa asentaa vain pakkauksen mukana olevassa malliluettelossa tai oheisessa Clix-esitteessä luetteluihin autoihin.

Huomio - Jos istuinsuojuksia ei ole asennettu ohjeiden mukaisesti, istuinturvatyyny eivät ehkä pääse täyttymään oikein onnettomuustilanteessa.

Säilytä pakkaus lasten ulottumattomissa – tukehtumisvaara!

GR



**ΣΗΜΑΝΤΙΚΟ**



### **Υποδείξεις ασφαλείας**

Η τοποθέτηση επιτρέπεται αποκλειστικά σε επιβατικά αυτοκίνητα σύμφωνα με τον κατάλογο τύπων οχημάτων που υπάρχει στη συσκευασία ή στο συνοδευτικό φυλλάδιο Clix.

Προσοχή - Εάν η τοποθέτηση δεν γίνει σωστά, δεν διασφαλίζεται η σωστή ενεργοποίηση του αερόσακου σε περίπτωση σύγκρουσης.

Κρατήστε τη συσκευασία μακριά από μικρά παιδιά – Κίνδυνος ασφυξίας!

PL



**WAŻNE INFORMACJE**



### **Wskazówki bezpieczeństwa**

Montera endast i personbilar enligt vad som tilläts på typlistan på förpackningen eller förföljande, detaljerade Clix-broschyr.

Försiktighet - Vid felaktig montering kan man inte garantera att airbags fungerar korrekt i händelse av en kollision.

Förvara förpackningen utom räckhåll för barn - kvävningrisk!

RU



VAŽNO

**Указания по технике безопасности**

Допускается применение только в легковых автомобилях согласно списку на упаковке или прилагаемой подробной брошюре Clix.

Осторожно! Если чехол закреплен неправильно, надлежащее срабатывание подушки безопасности в сидении при столкновении не гарантируется.

Храните упаковку в недоступном для детей месте. Опасность удушья!

HU



FONTOS

**Biztonsági tudnivalók**

Kizárólag a csomagolás vagy a mellékelt részletes Clix brosúra típuslistájában feltüntetett személygépkocsiba történő beépítés megengedett.

Figyelem – Nem megfelelő felszerelés esetén egy esetleges ütközéskor nem garantálható az oldallégzsák megfelelő működése.

A csomagolást kisgyermekektől távol kell tartani – fulladásveszély!

CZ



DŮLEŽITÉ UPOZORNĚNÍ

**Bezpečnostní pokyny**

Montáž je povolena výhradně do osobních vozů podle seznamu typů na obalu nebo přiložené podrobné brožury Clix.

Upozornění – V případě nesprávné instalace nelze zajistit správné nafouknutí airbagů při nárazu.

Obal ukládejte mimo dosah malých dětí, hrozí nebezpečí udušení!

SK



DÔLEŽITÉ UPOZORNENIE

**Bezpečnostné pokyny**

Montáž je povolená výhradne do osobných automobilov uvedených v prehľade typov na obale alebo v priloženej podrobnej brožúre Clix.

Pozor – Pri nesprávnej montáži sa správna aktivácia airbagu sedadla v prípade nárazu nedá zaručiť.

Obalové materiály neuchovávajte v dosahu malých detí - nebezpečenstvo udusenía!

HR



VAŽNO

**Sigurnosne upute**

Presvlake možete postaviti isključivo u osobna vozila prema uputama na pakiranju ili u priloženoj detaljnoj brošuri Službe za tehnički nadzor Clix.

Oprez – Kod nepravilno postavljenih presvlaka ne garantira se pravilno funkcioniranje zračnog jastuka u slučaju sudara.

Pakiranje držati daleko od djece – opasnost od gušenja!

TR



ÖNEMLİ

**Güvenlik uyarıları**

Yalnızca ambalaj üzerinde veya birlikte verilen ayrıntılı Clix broşüründeki tip listesinde yer alan araçlara takılmasına izin verilir.

Dikkat - Doğru bir şekilde takılmadığında herhangi bir kaza durumunda koltuk hava yastığının doğru olarak açılması garanti edilemez.

Ambalajı küçük çocuklardan uzak tutunuz – Boğulma tehlikesi!

NO



VIKTIG

**Sikkerhetsanvisninger**

Montering kun tillatt i privatbiler iht. modelliste på emballasjen eller medfølgende, detaljert Clix-brosjyre.

Forsiktig - Ved feilaktig montering, kan korrekt utløsning av airbags i tilfelle kollisjon ikke garanteres.

Hold emballasjen utenfor barns rekkevidde - kvelningsfare!

SL



POMEMBNO

**Varnostni napotki**

Namestitvev je dovoljena izključno v osebna vozila, zapisana na embalaži ali v priloženi brošuri Clix.

Pozor - Pri nepravilni namestitvi ni zagamčeno pravilno delovanje zračnih blazin v primeru trka.

Zaradi nevarnosti zadušitve embalažo hranite izven dosega otrok!



# IMPORTANT



## **Instrucțiuni de siguranță**

Este permis montajul în mod exclusiv numai în autoturismele menționate pe lista de mărci de pe ambalaj sau de pe broșura Clix detaliată anexată.

Atenție – în cazul unui montaj necorespunzător nu poate fi garantată ieșirea corectă a airbagului scaunului în caz de accident.

A se evita ajungerea ambalajului pe mâna copiilor mici – pericol de sufocare!



# ВАЖНО



## **Указания за безопасност**

Монтажът може да се извършва само в леки автомобили според типовия списък на опаковката или приложената подробна брошура на Съюза за технически надзор.

Внимание: В случай на несъобразен с изискванията монтаж не може да се осигури правилното отваряне на въздушната възглавница при удар.

Опаковката трябва да се държи настрана от малки деца – опасност от задушаване!



# ВАЖЛИВО



## **Вказівки щодо техніки безпеки**

Проводити встановлення виключно у легкових автомобілях відповідно до типового списку на упаковці або докладної брошури Clix, що додається.

Обережно - неналежний монтаж чохла може перешкоджати правильному спрацюванню подушки безпеки у разі зіткнення.

Зберігати упаковку у недоступному для дітей місці – небезпека удушення!

Service Adresse / Service address / Adresse:

WALSER GmbH • Produktion und Vertrieb  
Radetzkystrasse 114 • 6845 Hohenems • Austria  
Tel: +43(0)5576/7156-0 • Fax: +43(0)5576/71568  
E-mail: office@walsergroup.com • www.walsergroup.com

WALSER GmbH  
Langenweg 34 • Postf. 3325 • 88131 Lindau • Germany  
Tel: +49(0)8382/72221 • Fax: +49(0)8382/947461  
E-mail: office@walsergroup.com • www.walsergroup.com

WALSER Industrial Group Aktiengesellschaft  
Werkstrasse 10 • 9444 Diepoldsau • Switzerland  
Tel: +41(0)71/7300360 • Fax: +41(0)71/7300361  
E-mail: office@walsergroup.com • www.walsergroup.com