

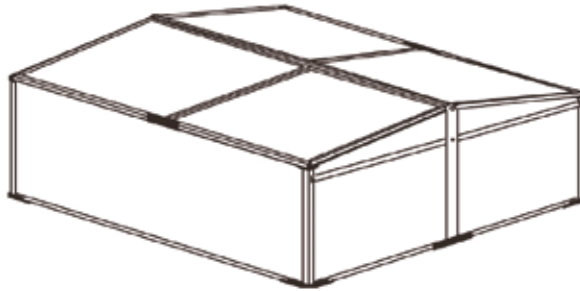











Montageanleitung

Für ebenen Stand auf vorbereitetem Substrat sorgen.
 Für Bodenkontakt am Rand ca. 5cm von Außen mit Substrat anhäufeln.
 Der Artikel ist sehr leicht, und ist bei Wind gegen Wegfliegen zu sichern.



Teil Nr.	Menge	Beschreibung
1	4Stück	
2	2Stück	
3	2Stück	
4	4Stück	
5	4Stück	
6	2Stück	
7	2Stück	
8	4Stück	
9	4Stück	
10	2Stück	
11	4Stück	
12	2Stück	

Bitte lesen Sie die Montageanleitung sorgfältig durch und bewahren diese für den späteren Gebrauch auf.

Montageanleitung

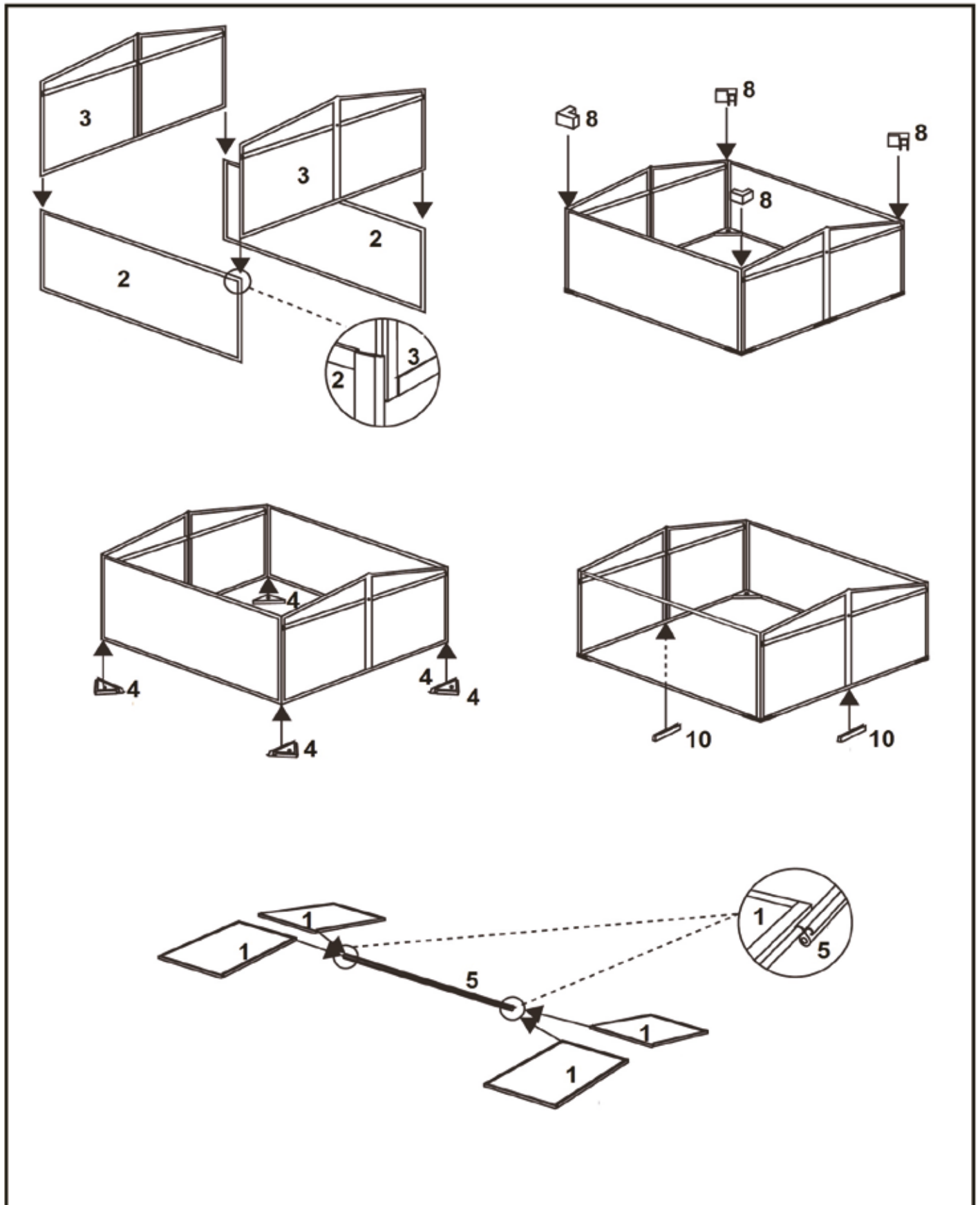

Montageanleitung

