



T1 Bitte unbedingt ausfüllen!

Name

Strasse

----- Ort -----
Plz

Tel.

T2 Sehr geehrte Kunden,
wir freuen uns, dass Sie sich für ein Produkt aus dem Hause Pelipal entschieden haben. Sollte es trotz aller Bemühungen unsererseits, Ihnen ein qualitativ hochwertiges Möbelstück zu liefern, zu Fehlteilen kommen, schicken Sie bitte dieses ausgefüllte Blatt an

Fax.: **+49 3443/434350**

E-Mail: **ersatzteile@pelipal.de**

Bitte beachten Sie, dass Bauteile über 800mm Länge und 350mm Breite direkt bei Ihrem Möbelhändler zu beanstanden sind. Zur Reklamationsbearbeitung ist es unbedingt erforderlich **die Artikelnummer des Schrankes**, welche auf dem Etikett ersichtlich ist und den Markt, wo das Möbel erworben wurde anzugeben. Außerdem tragen Sie unten bitte die benötigte Stückzahl ein. Viel Spaß mit Ihrem neuen Badmöbel! Ihr Pelipal Team

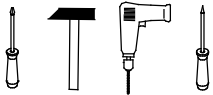

T3 Für den Zusammenbau sind 2 Personen erforderlich.

T4 Montage-Richtzeit 3 Stunden

8 x a EXZENTER-000015	Stück	8 x b DUEB-SMD-000005	Stück	4 x c TRAE-001-000020	Stück	2 x d TBD-35-115X00	Stück	2 x e ZPL-003X004	Stück
16 x f SCH-KA-063X011	Stück	8 x g SCH-SPA-035X015	Stück	1 x h AUF-001-000080	Stück	1 x j AUF-001-000090	Stück	2 x k AUF-001-000020	Stück
4 x l NAGEL-025X001	Stück	1 x m TUER-DAEM-000010	Stück	1 x n TUER-ADA-000010	Stück	3 x o Griff	Stück	6 x p SCH-RDK-045X045	Stück
2 x q ADK-AL1-005X008	Stück	2 x r RWD-KEI-000060	Stück	1 x s VBD-000020	Stück	1 x t SCH-RDK-045X045	Stück	1 x u SCH-RDK-040X015	Stück
2 x IT01 KA-260-LI	Stück		2 x IT02 KA-260-RE	Stück					
2 x IT03 ZAR-260-LI	Stück		2 x IT04 ZAR-260-RE	Stück		4 x IT05 ADK-ZAR-ALU	Stück		
24 x IT06 SCH-RDK-040X015	Stück	2 x IT07 VBD-ZAR-LI-70	Stück	2 x IT08 VBD-ZAR-RE-70	Stück	4 x IT09 VBD-ZAR-FRO	Stück		

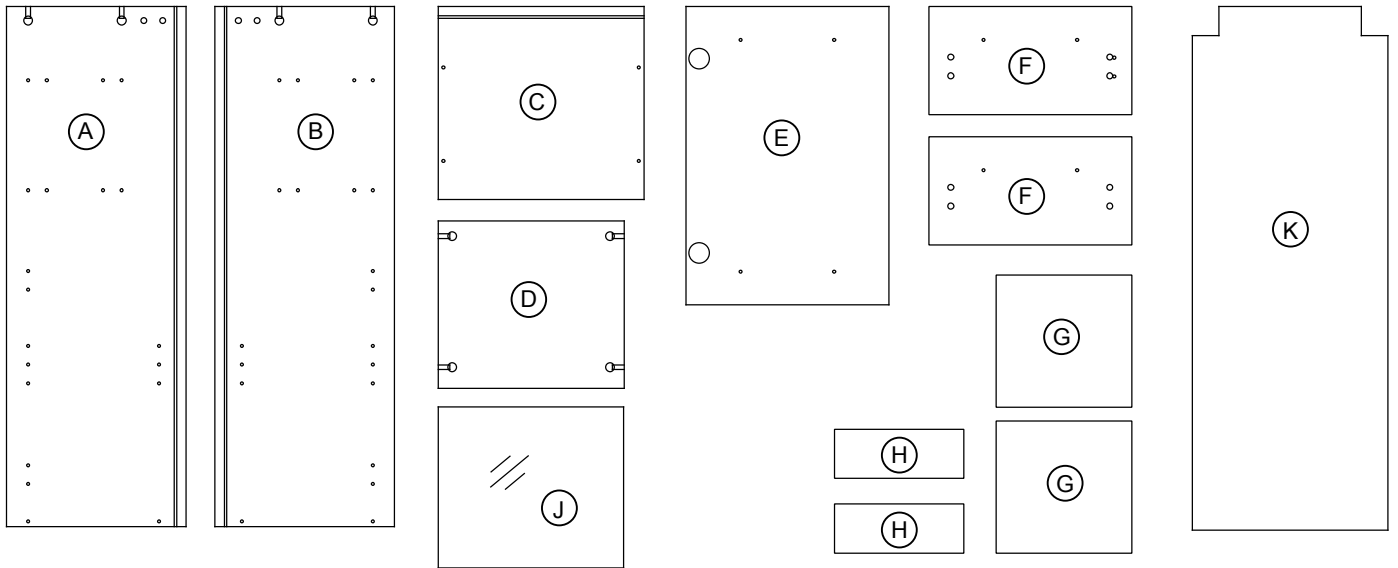

1.

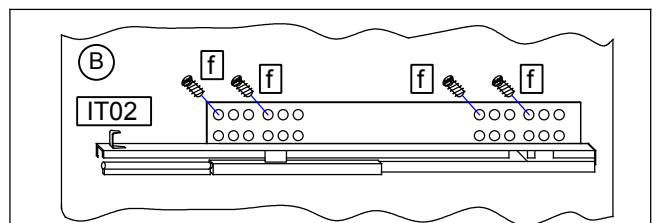
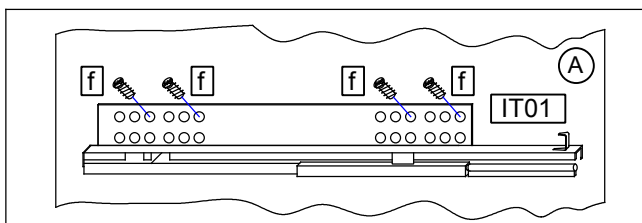
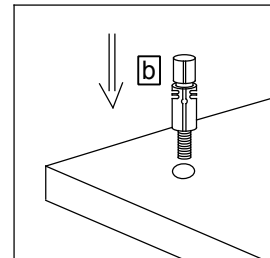
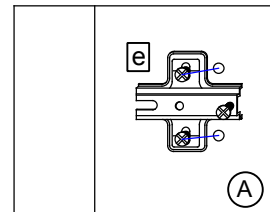
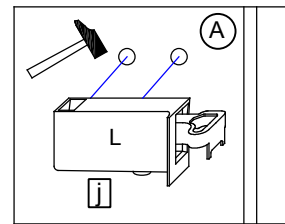
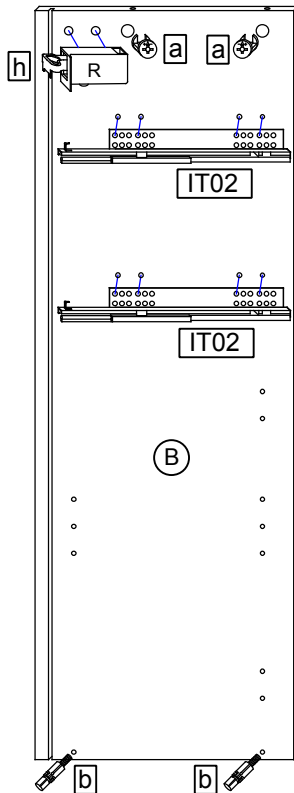
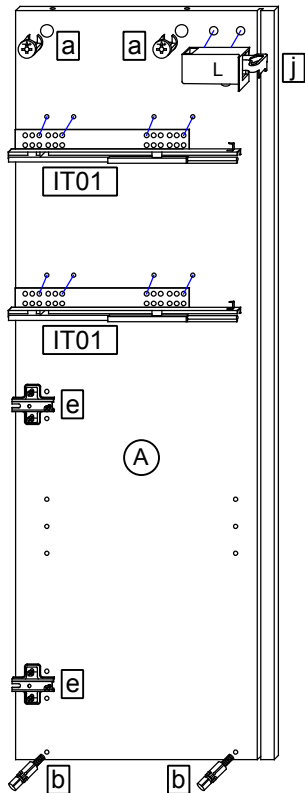
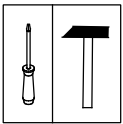

2.

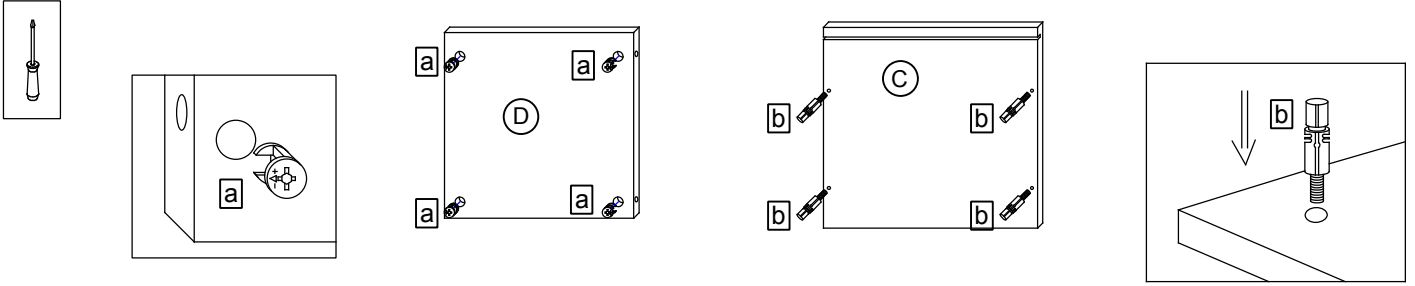

3.

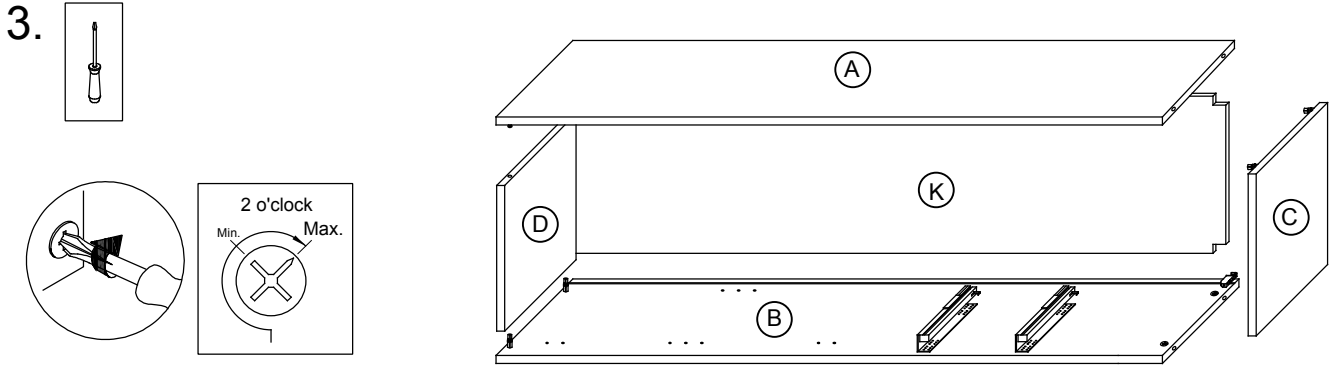

4.

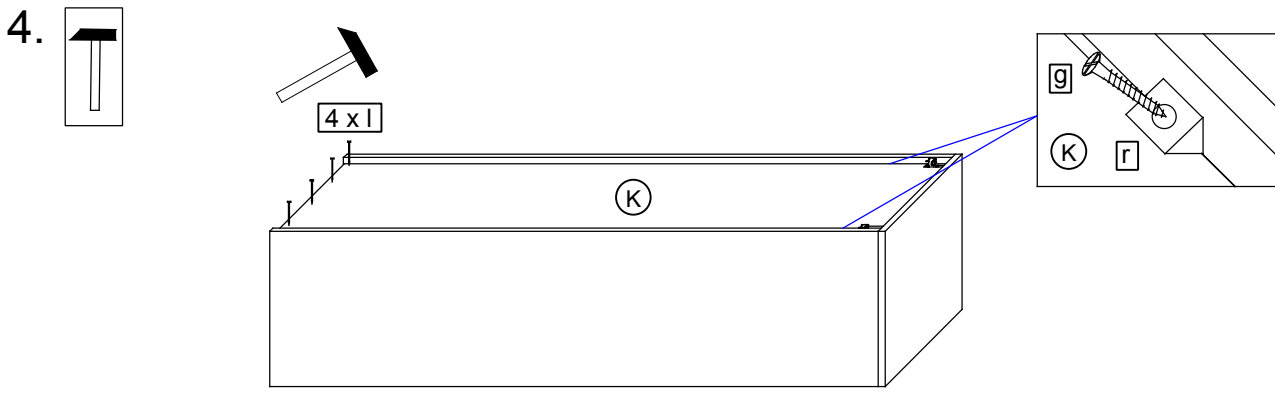

5.

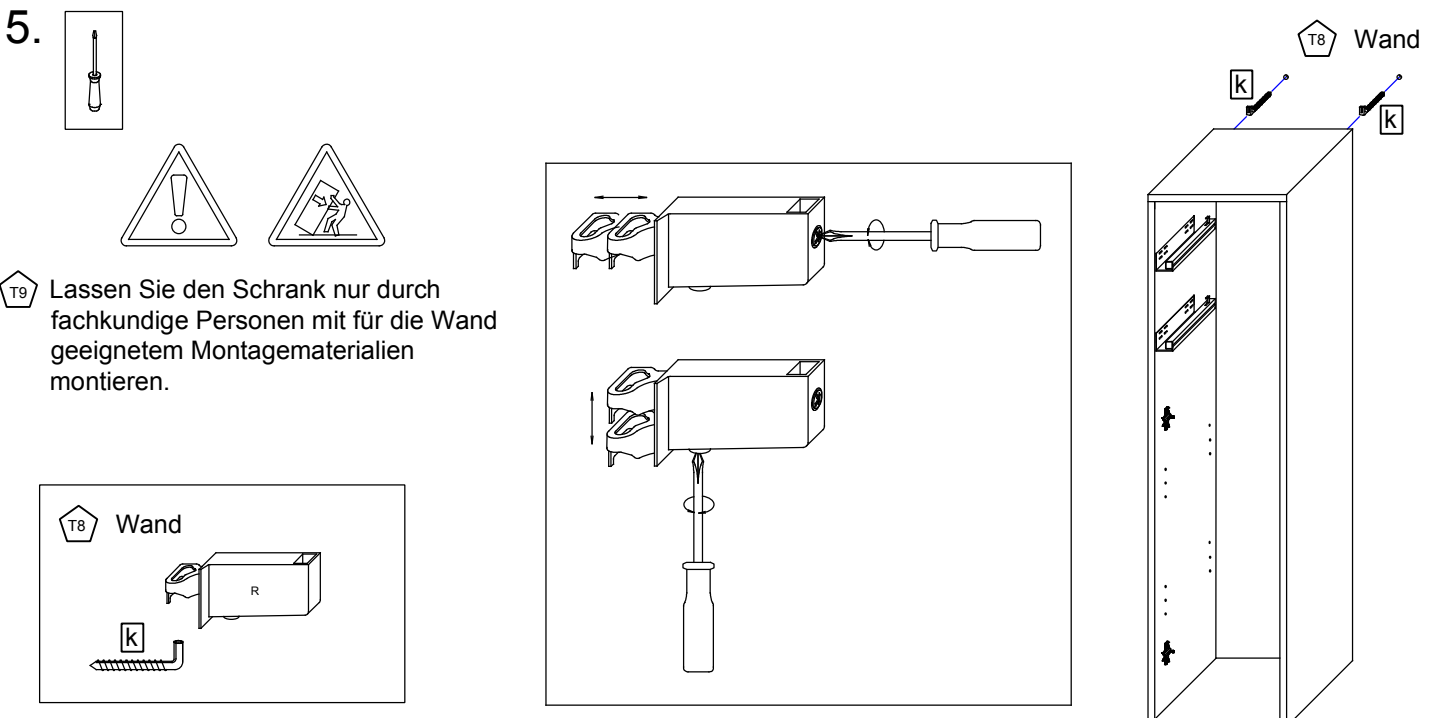

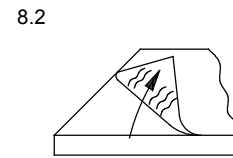
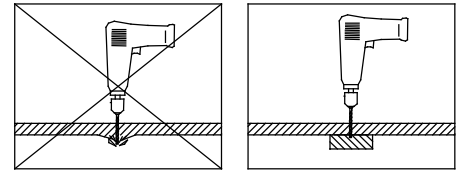
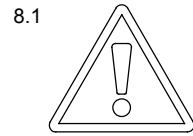
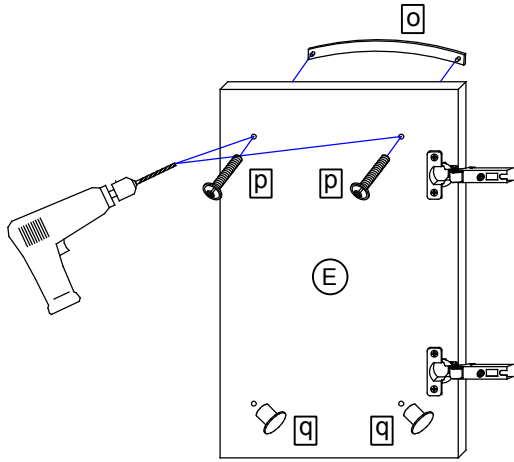
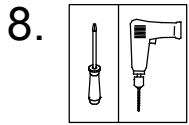
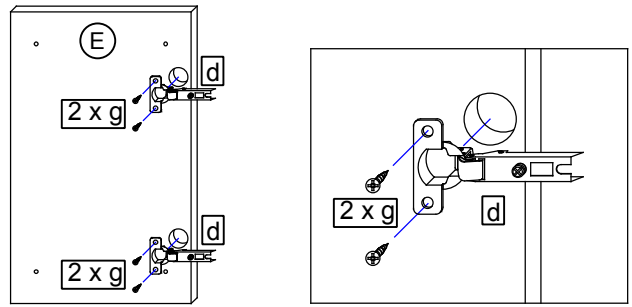
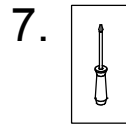
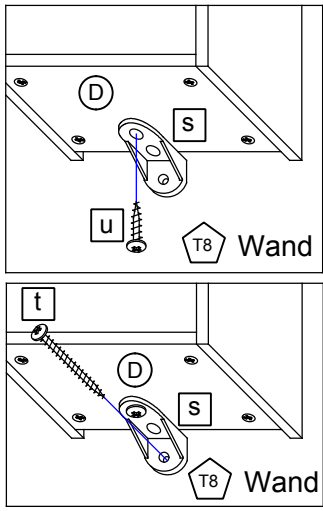
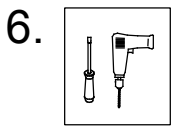

Bei Hochglanz-Fronten bitte erst die Schutzfolie entfernen und dann den Griff montieren!

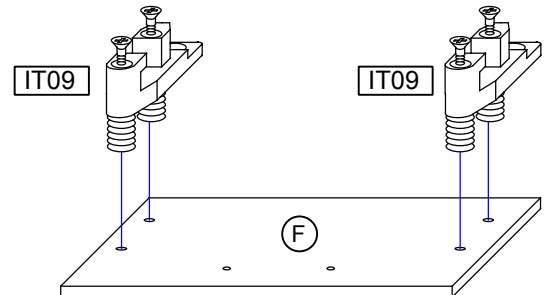
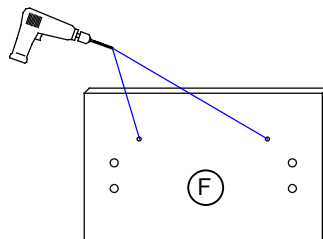
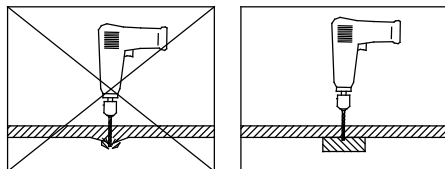
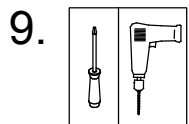
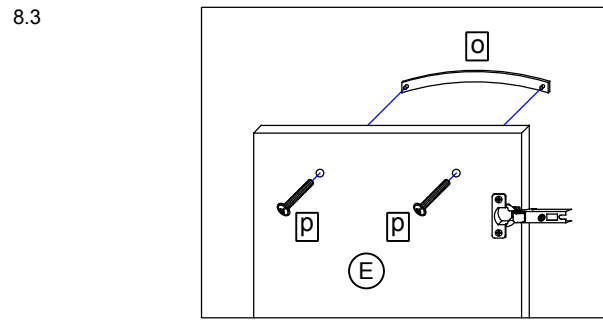

10.

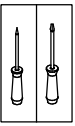

Bei Türmontage das Scharnier einhängen, bis Anschlag öffnen und anschließend festschrauben.

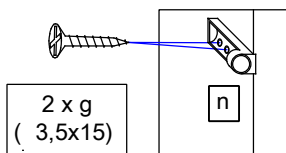
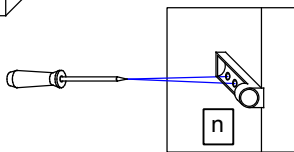
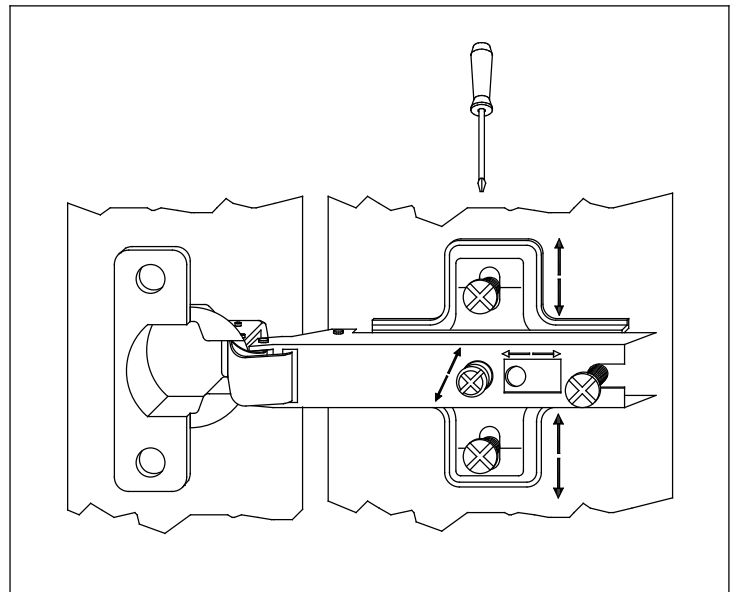
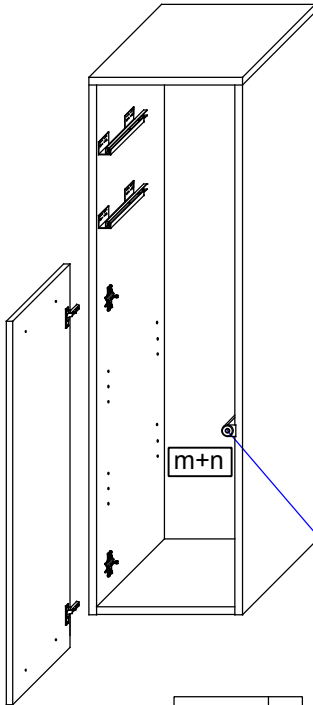
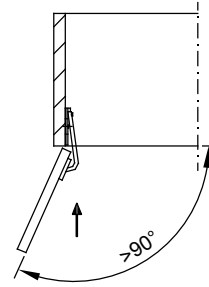

2 x g
(3,5x15)

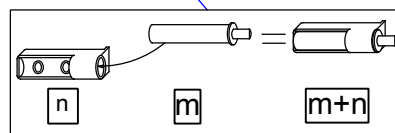

11.

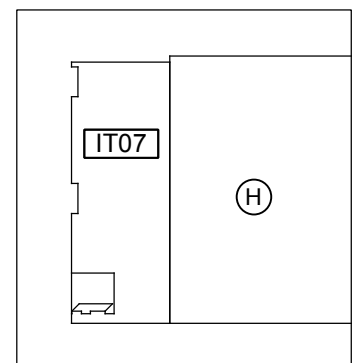
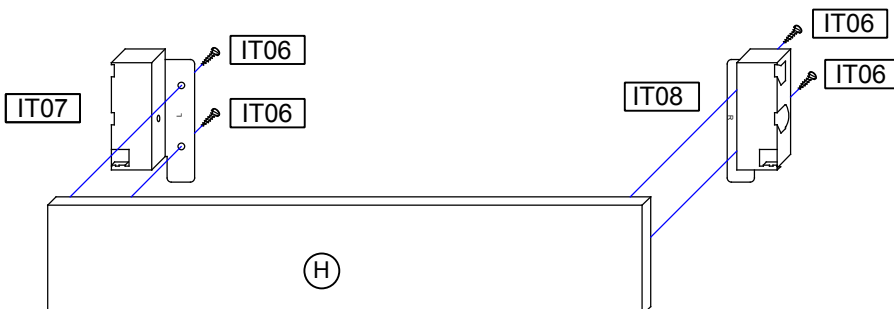
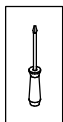

12.

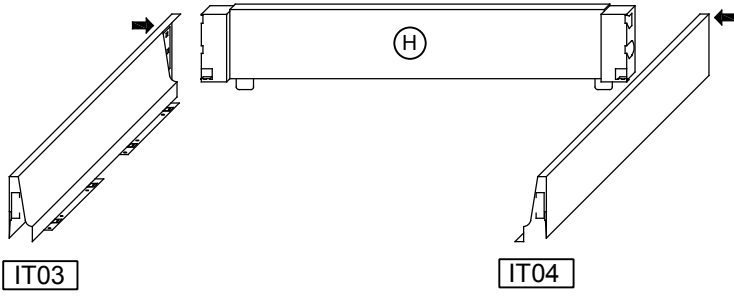

13.

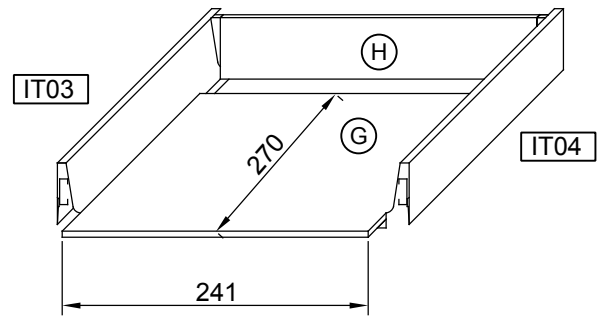

14.

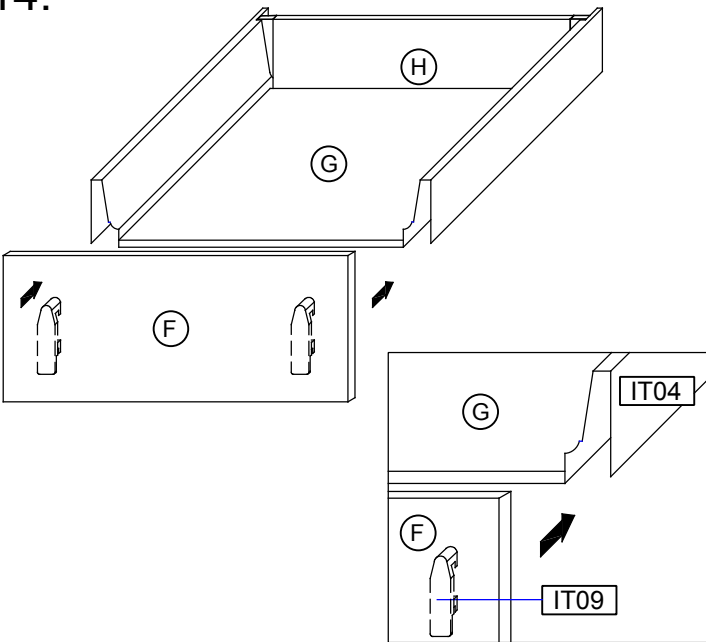

15.

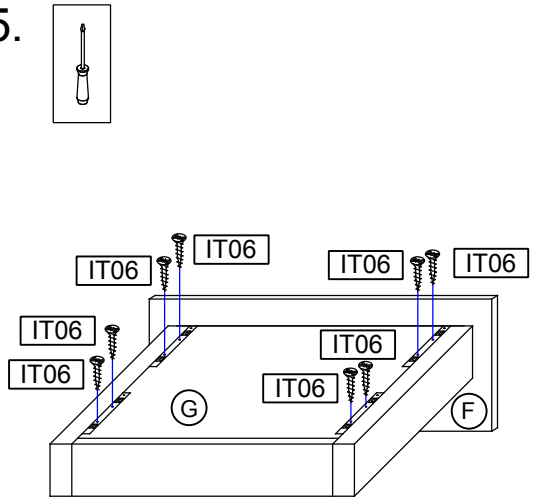

16.

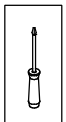

T10

Bei Hochglanz-Fronten bitte erst die Schutzfolie entfernen und dann den Griff montieren!

16.1

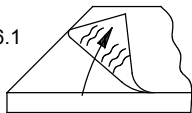

16.2

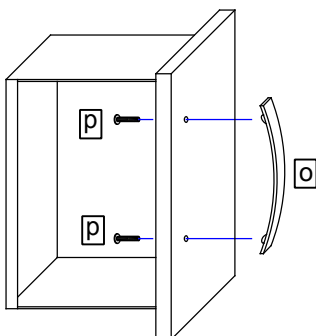

17.

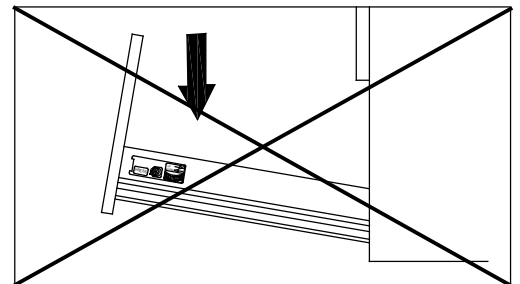
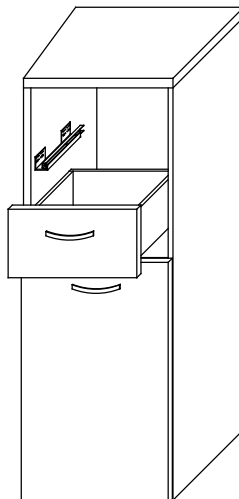

17.1

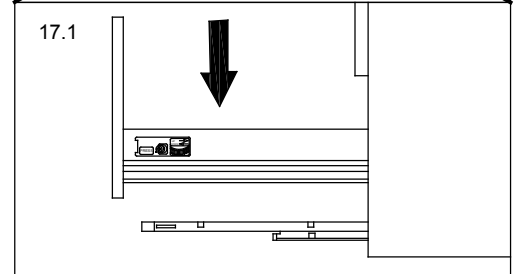

17.2

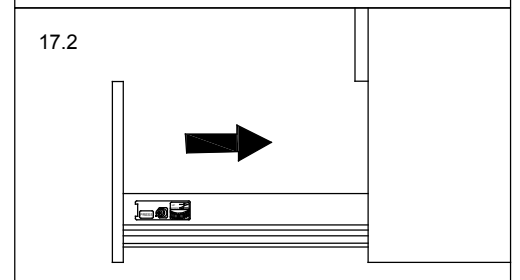

18.

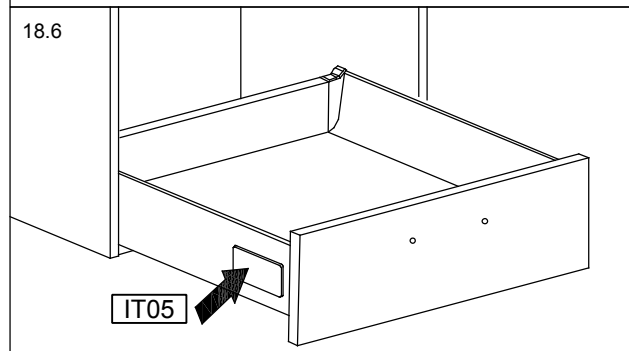
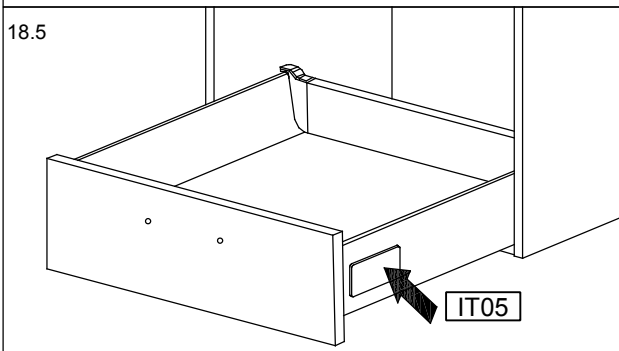
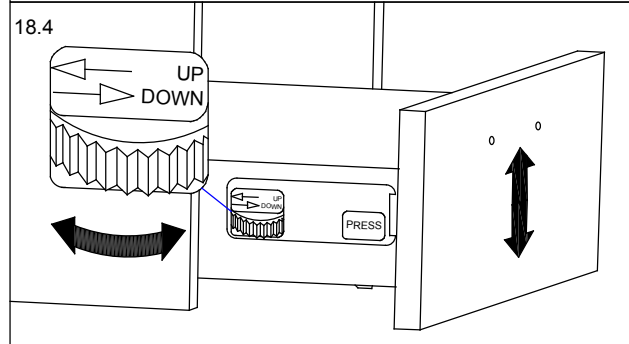
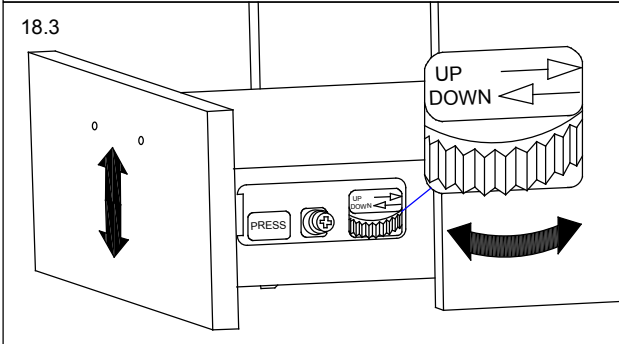
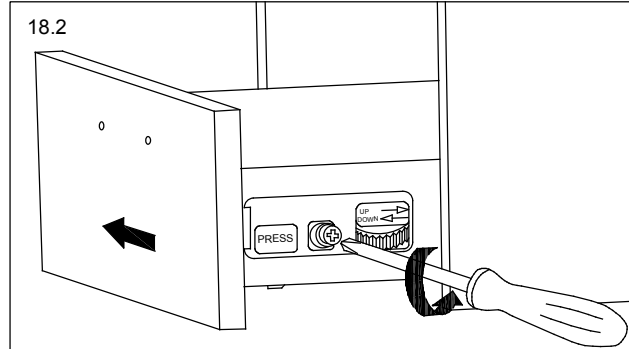
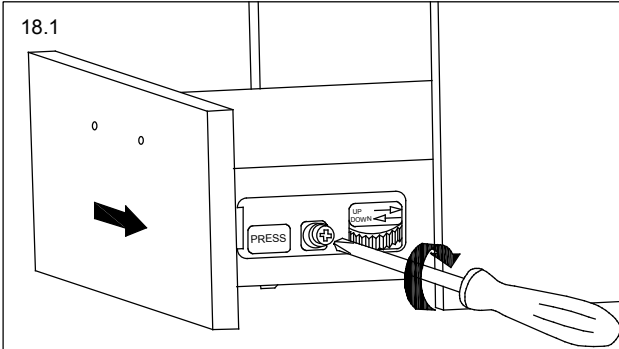
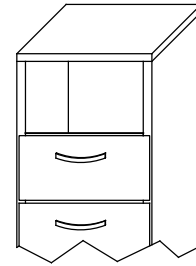
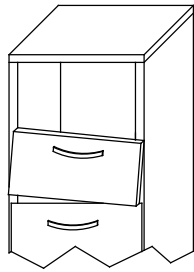
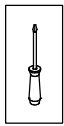

19.

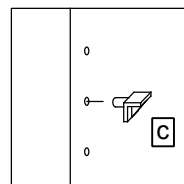
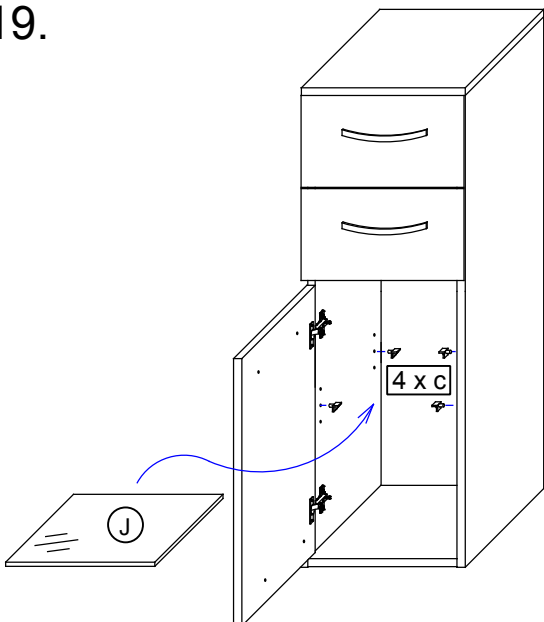

Das Möbel bitte nur mit einem feuchten Tuch reinigen.