

3 _ _ -015030

T1 Bitte unbedingt ausfüllen!

Name -----
Strasse -----
Plz ----- Ort -----
Tel. -----

T2 Sehr geehrte Kunden,
wir freuen uns, dass Sie sich für ein Produkt aus dem Hause Pelipal entschieden haben. Sollte es trotz aller Bemühungen unsererseits, Ihnen ein qualitativ hochwertiges Möbelstück zu liefern, zu Fehlteilen kommen, schicken Sie bitte dieses ausgefüllte Blatt an
Fax.: **+49 3443/434350**
E-Mail: **ersatzteile@pelipal.de**
Bitte beachten Sie, dass Bauteile über 800mm Länge und 350mm Breite direkt bei Ihrem Möbelhändler zu beanstanden sind. Zur Reklamationsbearbeitung ist es unbedingt erforderlich **die Artikelnummer des Schrankes**, welche auf dem Etikett ersichtlich ist und den Markt, wo das Möbel erworben wurde anzugeben. Außerdem tragen Sie unten bitte die benötigte Stückzahl ein. Viel Spaß mit Ihrem neuen Badmöbel! Ihr Pelipal Team

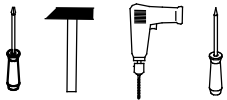





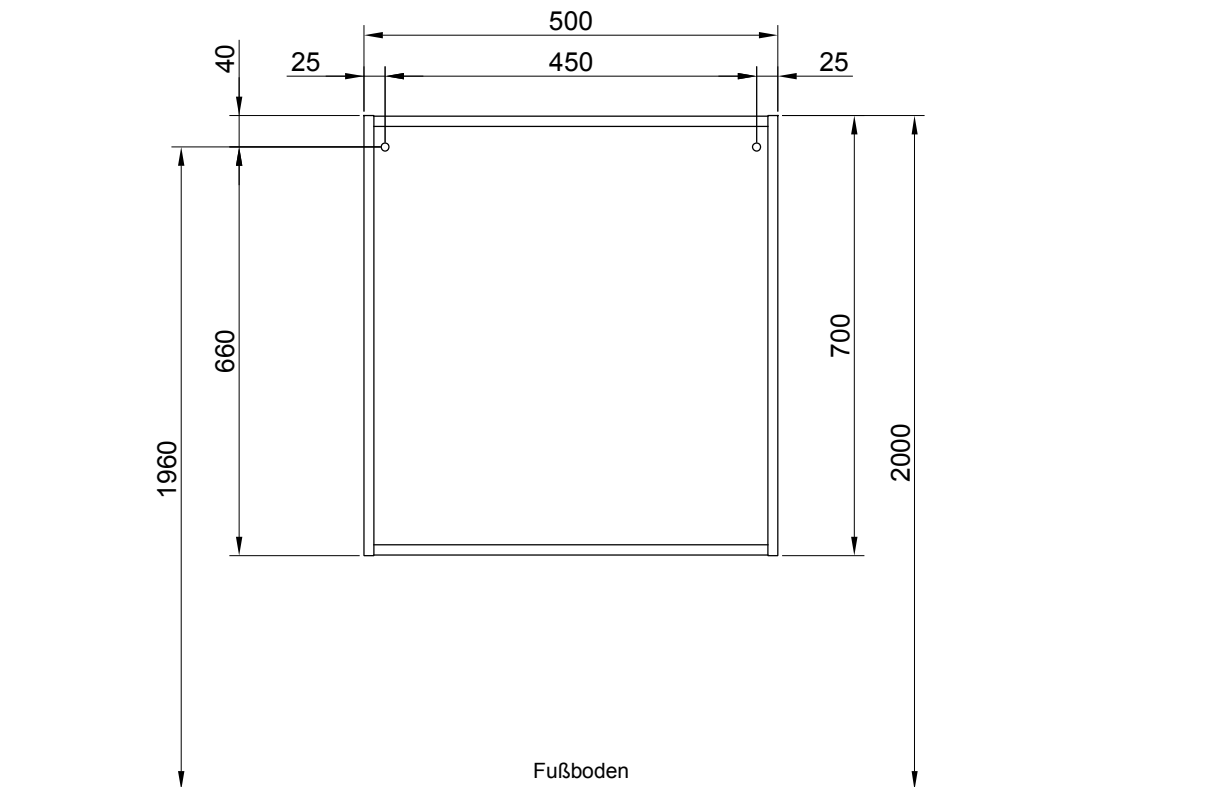



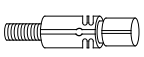

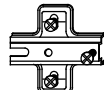
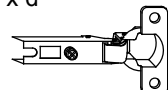
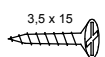
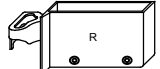
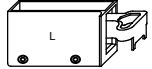
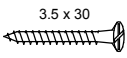
T3 Für den Zusammenbau sind 2 Personen erforderlich.

T4 Montage-Richtzeit 3 Stunden

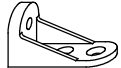
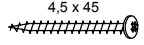

Die Maßangabe der Höhe ist nicht bindend!

<p>8 x a</p>  <p>DÜB-SMD-000005</p>	Stück	<p>8 x b</p>  <p>EXZENTER-000015</p>	Stück	<p>4 x c</p>  <p>ZPL-016X000</p>	Stück	<p>4 x d</p>  <p>TBD-26-115X00</p>	Stück	<p>8 x e</p>  <p>SCH-SPA-035X015</p>	Stück
<p>1 x f</p>  <p>AUF-001-000085</p>	Stück	<p>1 x g</p>  <p>AUF-001-000095</p>	Stück	<p>4 x h</p>  <p>SCH-SPA-035X030</p>	Stück	<p>2 x i</p>  <p>AUF-001-000020</p>	Stück	<p>8 x k</p>  <p>TRAE-001-000020</p>	Stück
<p>2 x l</p>  <p>Griff</p>	Stück	<p>4 x m</p>  <p>ADK-AL1-005X008</p>	Stück	<p>4 x n</p>  <p>ADK-AL1-005X008</p>	Stück	<p>12 x o</p>  <p>NAGEL-025X001</p>	Stück	<p>1 x p</p>  <p>VBD-000020</p>	Stück
<p>1 x r</p>  <p>SCH-RDK-045X045</p>	Stück	<p>1 x s</p>  <p>SCH-RDK-040X015</p>	Stück		Stück		Stück		Stück

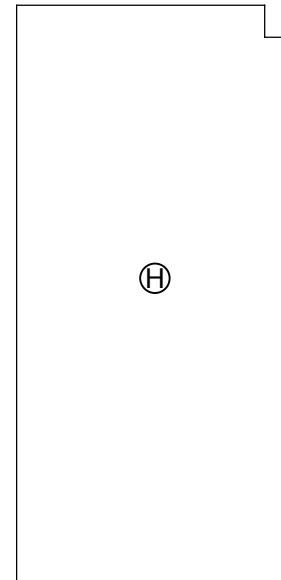
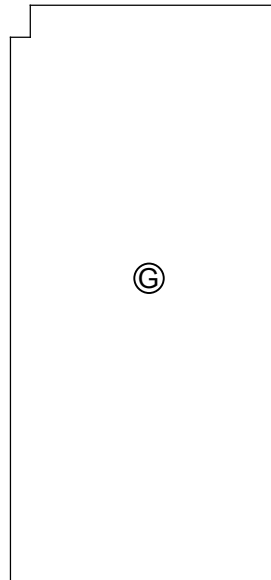
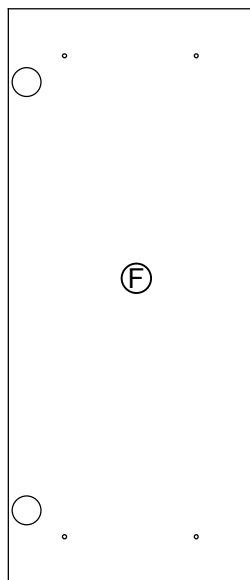
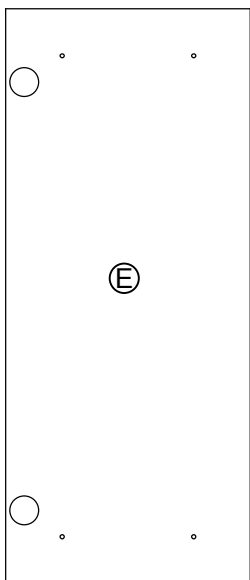
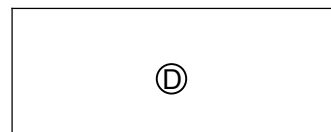
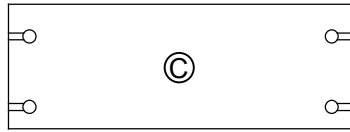
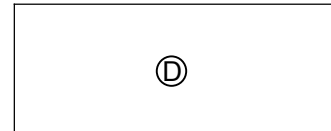
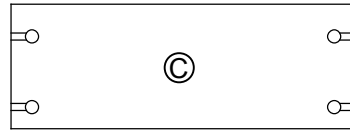
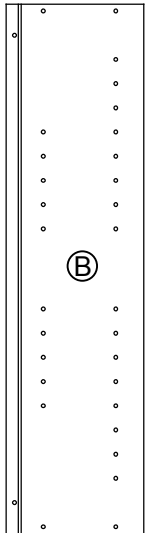
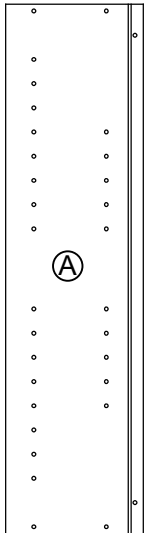

1.

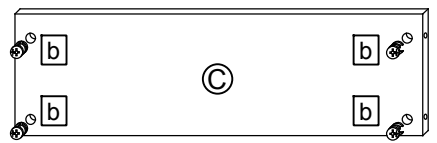
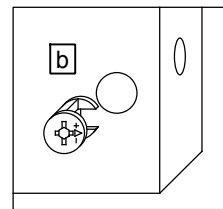
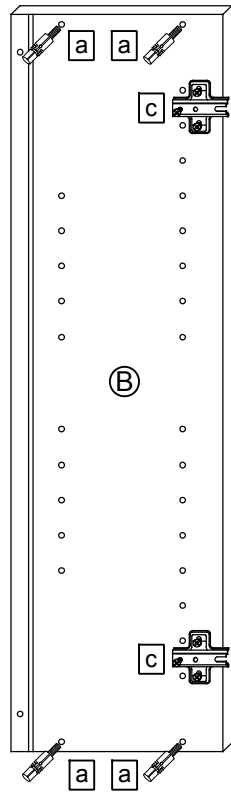
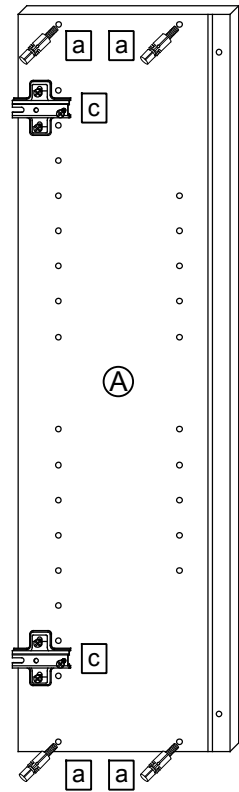
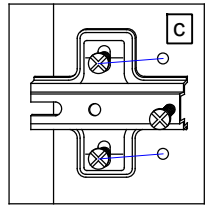
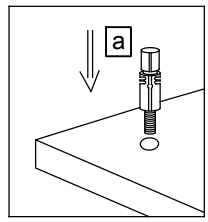
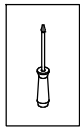

2.

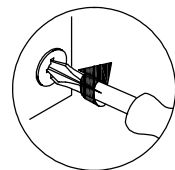
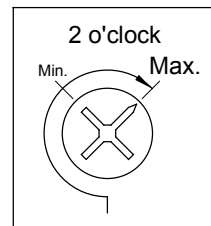
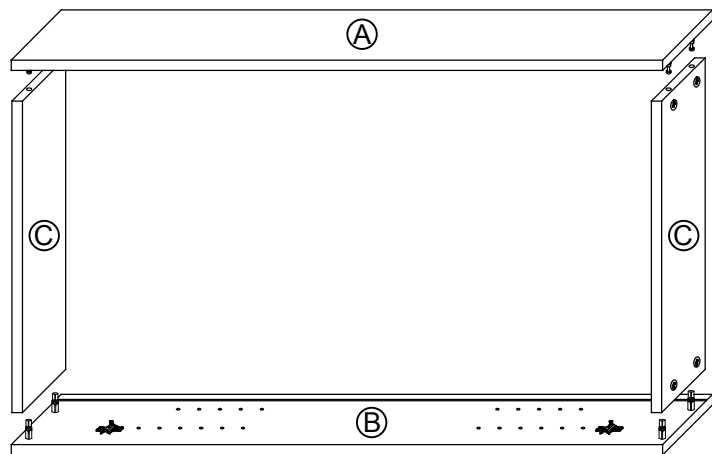
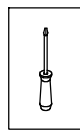

3.

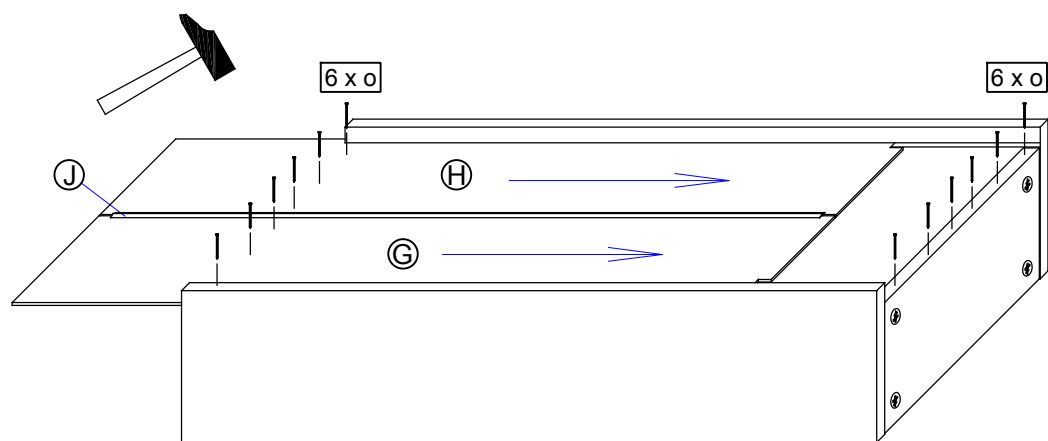
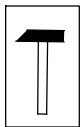

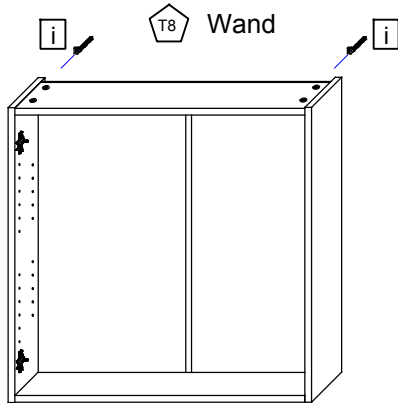
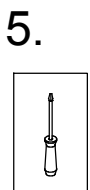
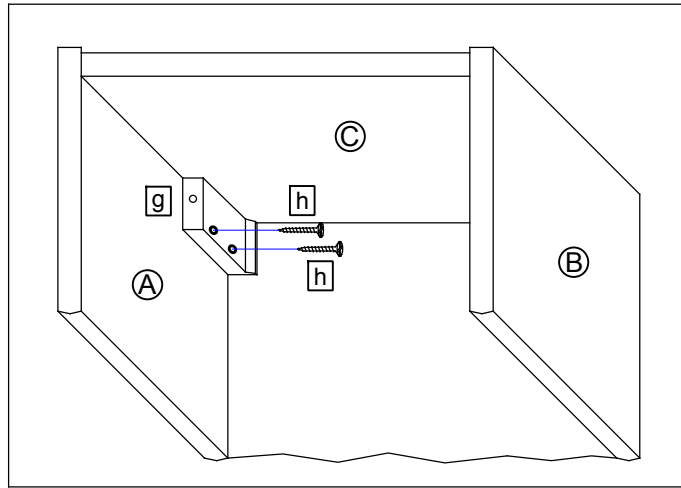
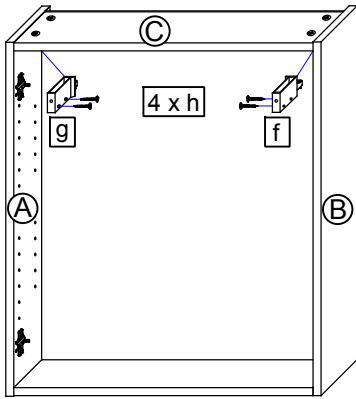
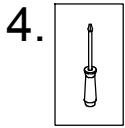

T37 Achtung! Bei fehlerhafter Montage können Schäden durch das Herabstürzen des Schrankes entstehen.

T9 Lassen Sie den Schrank nur durch fachkundige Personen mit für die Wand geeignetem Montagematerialien montieren.

T38 Achten Sie beim Aufhängen des Schrankes darauf, dass der Schrankaufhänger richtig in den Schraubhaken einrastet.

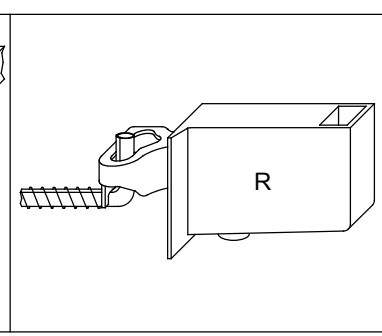
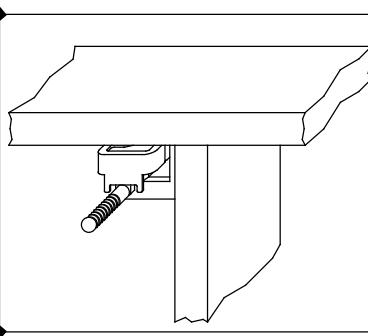
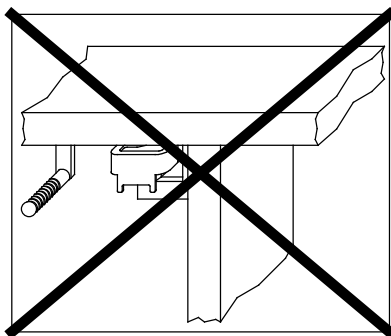
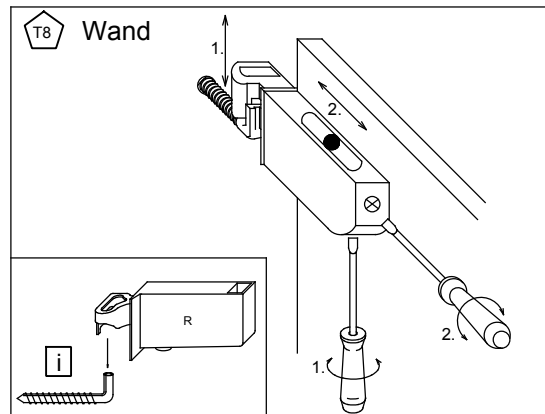
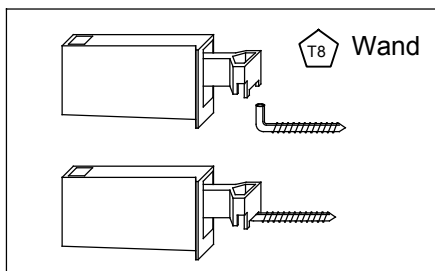

6.

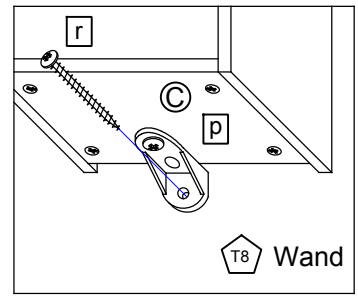
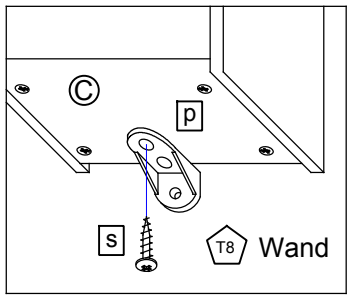
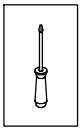

7.

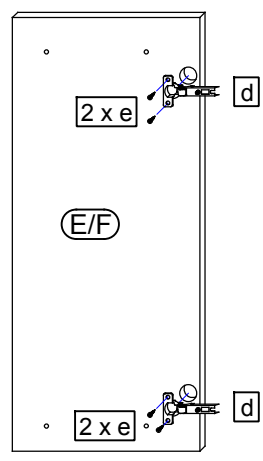
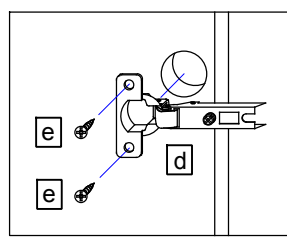
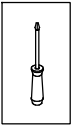

8.

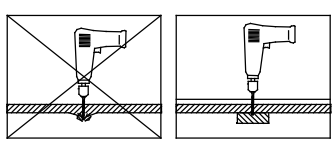

8.1

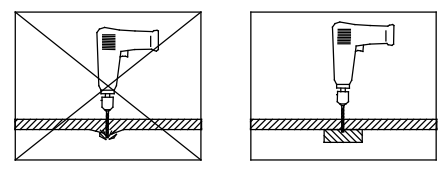

8.2



Bei Hochglanz-Fronten bitte erst die Schutzfolie entfernen und dann den Griff montieren!

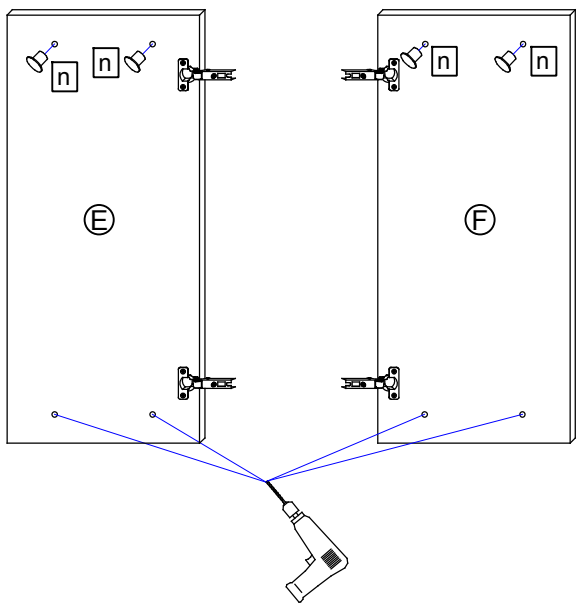
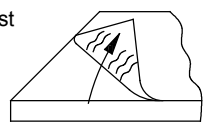

8.3

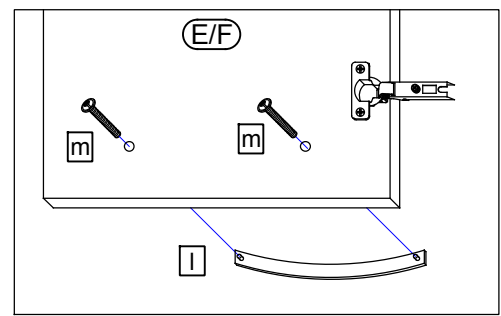

9.

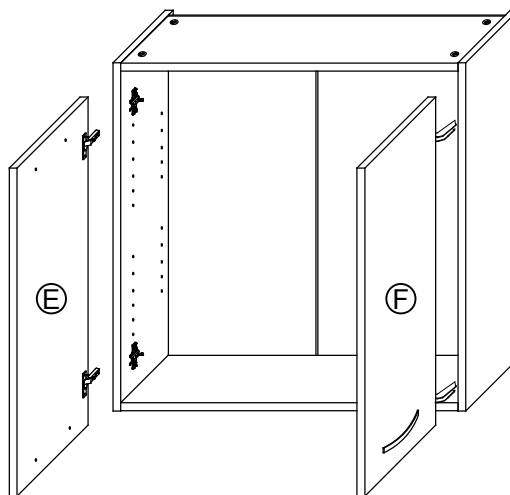
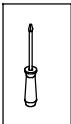

T11

Bei Türmontage das Scharnier einhängen, bis Anschlag öffnen und anschließend festschrauben.

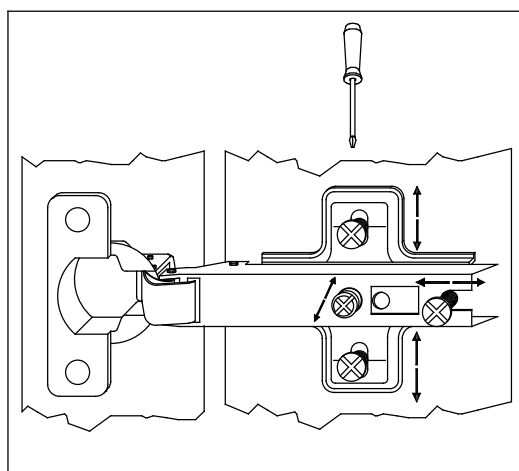
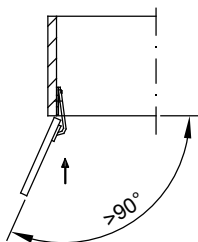

10.

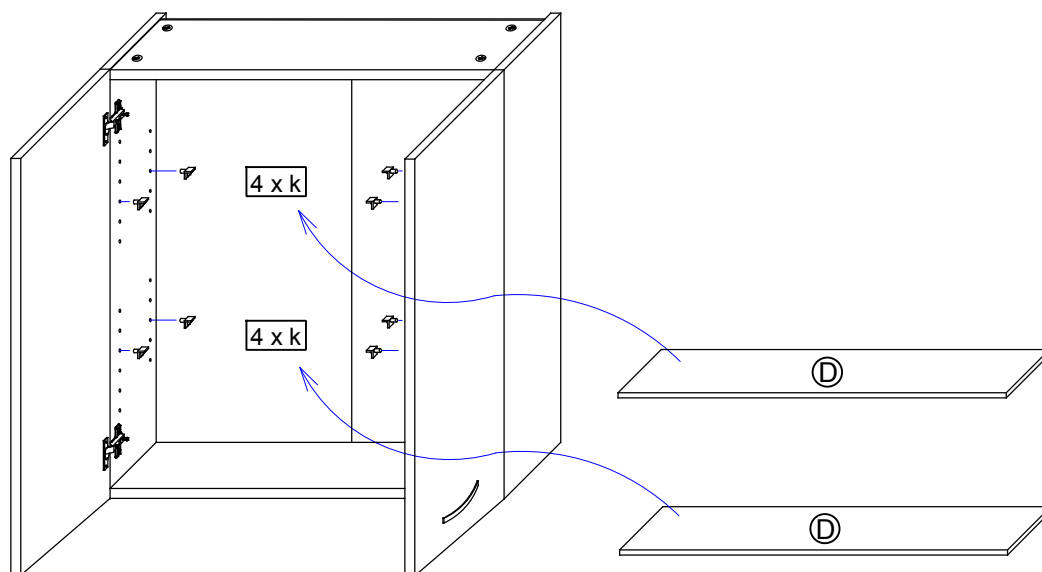

T12

Das Möbel bitte nur mit einem feuchten Tuch reinigen.