

3\_\_-013556

9\_\_-013556

T1

Bitte unbedingt ausfüllen!

|         |     |
|---------|-----|
| Name    |     |
| Strasse |     |
| PLZ     | Ort |
| Tel.    |     |

T2

Sehr geehrte Kunden,  
wir freuen uns, dass Sie sich für ein Produkt aus dem Hause Pelipal entschieden haben. Sollte es trotz aller Bemühungen unsererseits, Ihnen ein qualitativ hochwertiges Möbelstück zu liefern, zu Fehlteilen kommen, schicken Sie bitte dieses ausgefüllte Blatt an

Fax.: **+49 3443/434350**

E-Mail: **ersatzteile@pelipal.de**

Bitte beachten Sie, dass Bauteile über 800mm Länge und 350mm Breite direkt bei Ihrem Möbelhändler zu beanstanden sind. Zur Reklamationsbearbeitung ist es unbedingt erforderlich **die Artikelnummer des Schrankes**, welche auf dem Etikett ersichtlich ist und den Markt, wo das Möbel erworben wurde anzugeben. Außerdem tragen Sie unten bitte die benötigte Stückzahl ein. Viel Spaß mit Ihrem neuen Badmöbel!

Ihr Pelipal Team

|   |
|---|
| - |
|---|

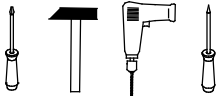

T3







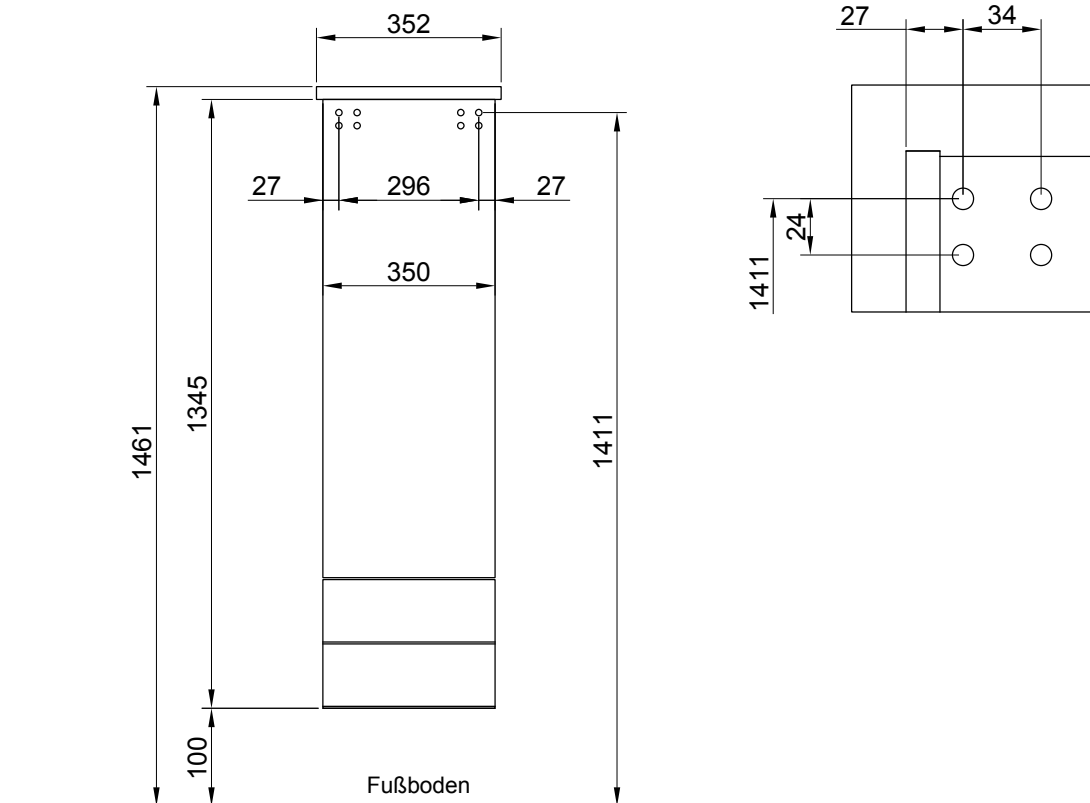



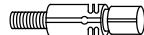

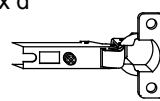
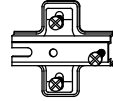

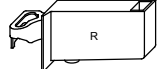

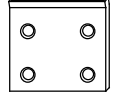

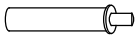

Für den Zusammenbau sind 2 Personen erforderlich.

T4

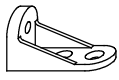
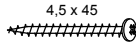
Montage-Richtzeit 3 Stunden

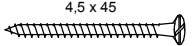
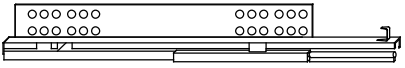
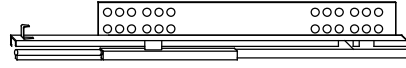

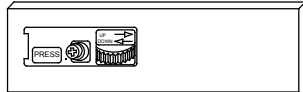
Die Maßangabe der Höhe ist nicht bindend!

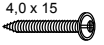
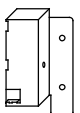
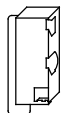
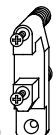
|   |       |  |       |  |       |  |       |  |       |
|---|-------|--|-------|--|-------|--|-------|--|-------|
| 12 x a<br><br>EXZENTER-000015      | Stück | 12 x b<br><br>DUEB-SMD-000005   | Stück | 12 x c<br><br>TRAE-001-000020   | Stück | 5 x d<br><br>TBD-35-115X00     | Stück | 5 x e<br><br>ZPL-003X004      | Stück |
| 16 x f<br><br>SCH-KA-063X011       | Stück | 14 x g<br><br>SCH-SPA-035X015   | Stück | 1 x h<br><br>AUF-001-000080     | Stück | 1 x j<br><br>AUF-001-000090    | Stück | 2 x k<br><br>AUF-001-000030   | Stück |
| 12 x l<br><br>NAGEL-025X001        | Stück | 2 x m<br><br>TUER-DAEM-000010   | Stück | 2 x n<br><br>TUER-ADA-000010    | Stück | 4 x o<br><br>Griff             | Stück | 8 x p<br><br>SCH-SPA-045X045  | Stück |
| 4 x q<br><br>ADK-AL1-005X008       | Stück | 2 x r<br><br>RWD-KEI-000060     | Stück | 1 x s<br><br>VBD-000020         | Stück | 1 x t<br><br>SCH-RDK-045X045   | Stück | 1 x u<br><br>SCH-RDK-040X015  | Stück |
| 8 x v<br><br>SCH-SPA-045X045        | Stück |  | Stück |  | Stück |  | Stück |  | Stück |
| 2 x IT01<br><br>KA-260-LI         |       |  | Stück | 2 x IT02<br><br>KA-260-RE     |       |  | Stück |  | Stück |
| 2 x IT03<br><br>ZAR-260-LI       |       |  | Stück | 2 x IT04<br><br>ZAR-260-RE   |       |  | Stück | 4 x IT05<br><br>ADK-ZAR-ALU | Stück |
| 24 x IT06<br><br>SCH-RDK-040X015 | Stück | 2 x IT07<br><br>VBD-ZAR-LI-70 | Stück | 2 x IT08<br><br>VBD-ZAR-RE-70 | Stück | 4 x IT09<br><br>VBD-ZAR-FRO | Stück |  | Stück |

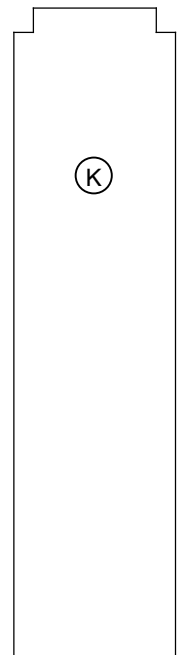
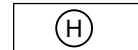
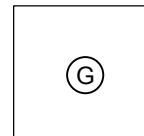
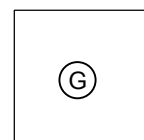
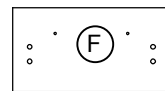
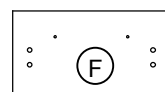
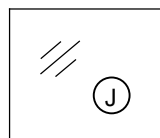
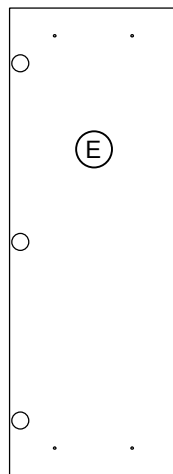
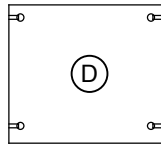
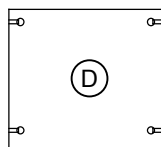
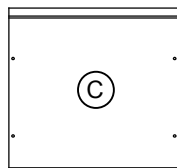
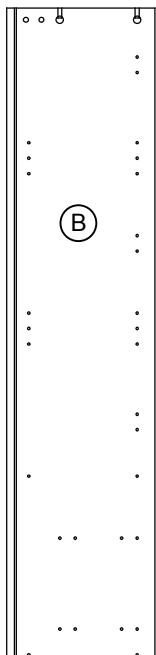
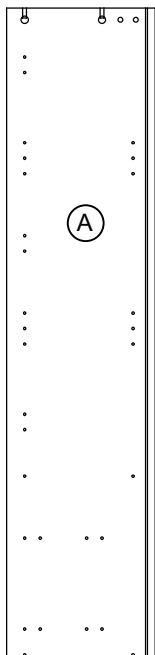

1.

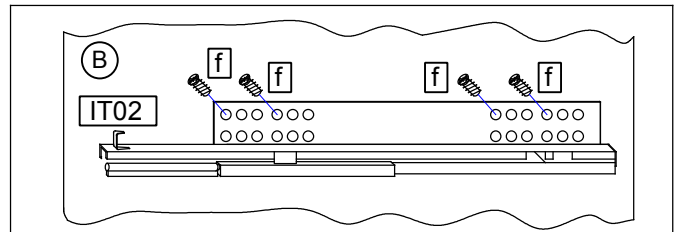
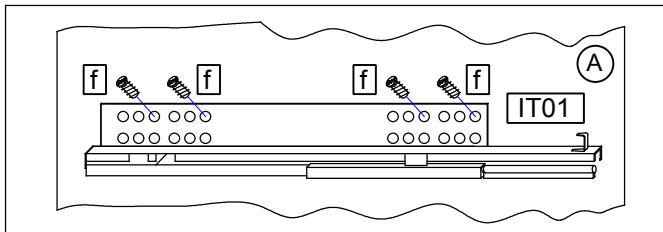
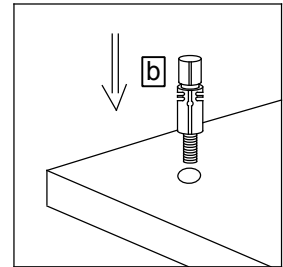
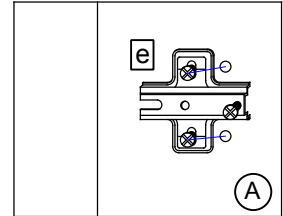
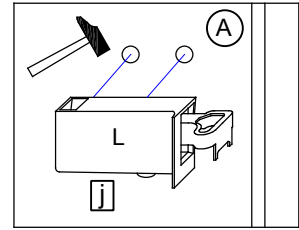
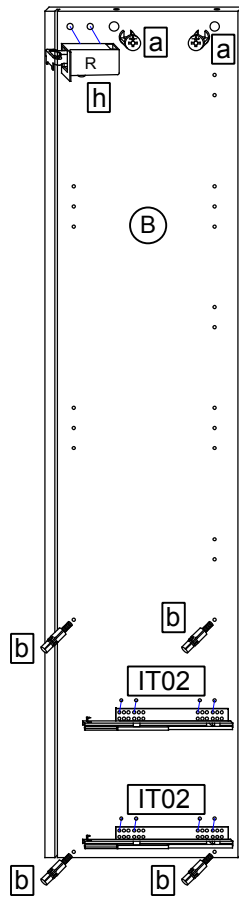
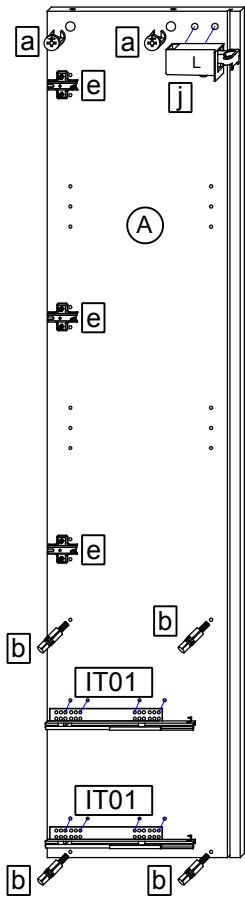
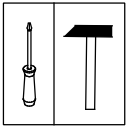

2.

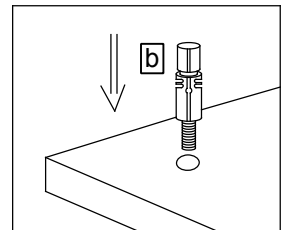
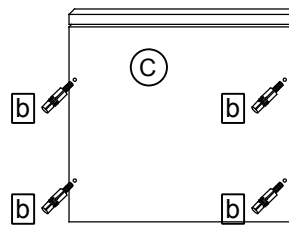
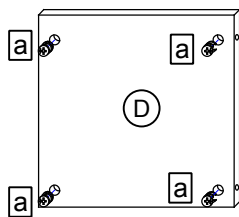
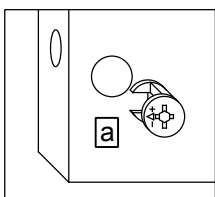
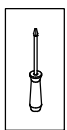

3.

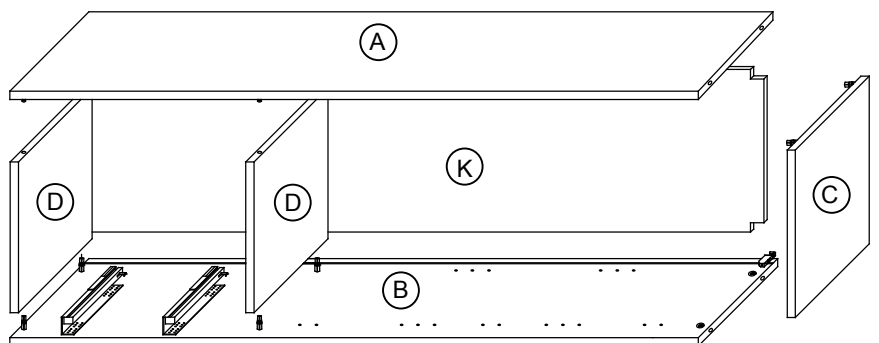
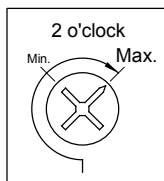
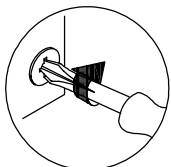
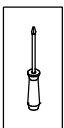

4.

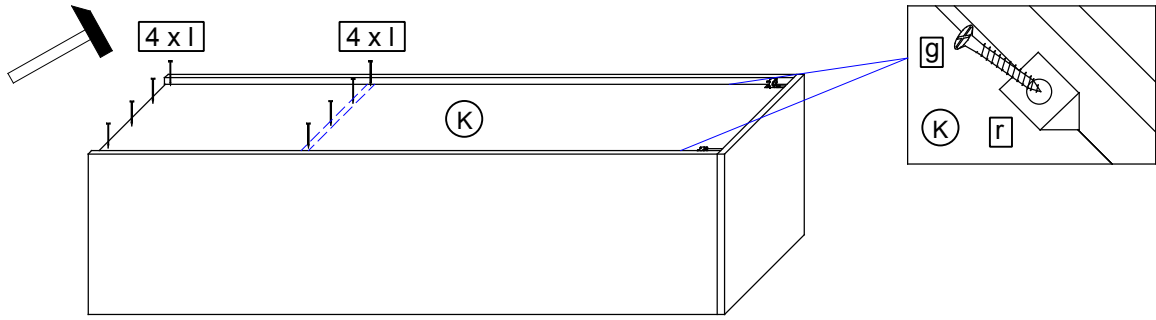
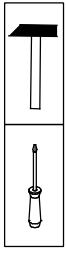

5.

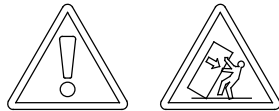
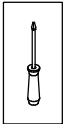

- T9 Lassen Sie den Schrank nur durch fachkundige Personen mit für die Wand geeignetem Montagematerialien montieren.
- T6 Die Schrankaufhänger dienen zur Kippsicherung des Schrankes und müssen grundsätzlich montiert werden.

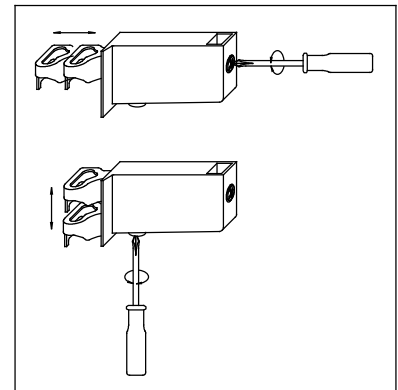
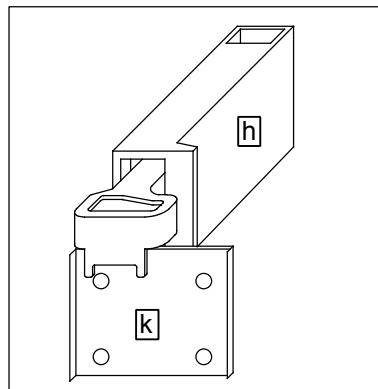
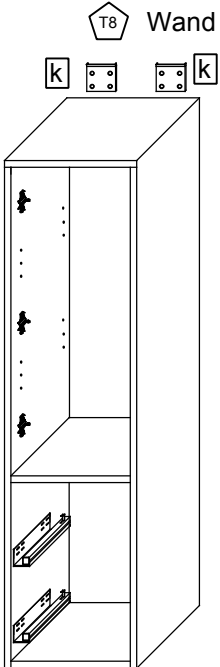
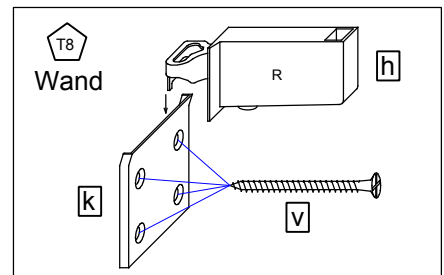

6.

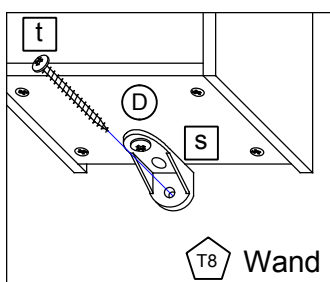
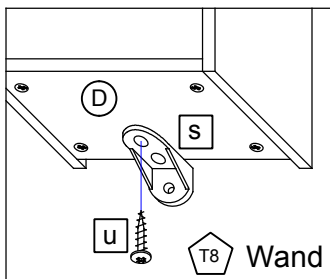
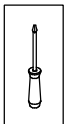

7.

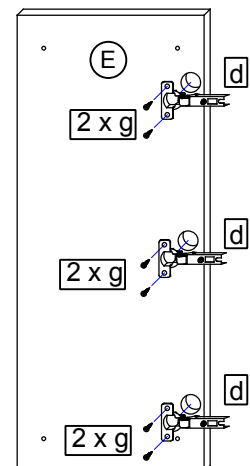
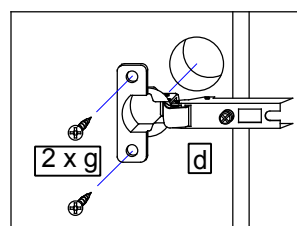
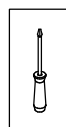

8.

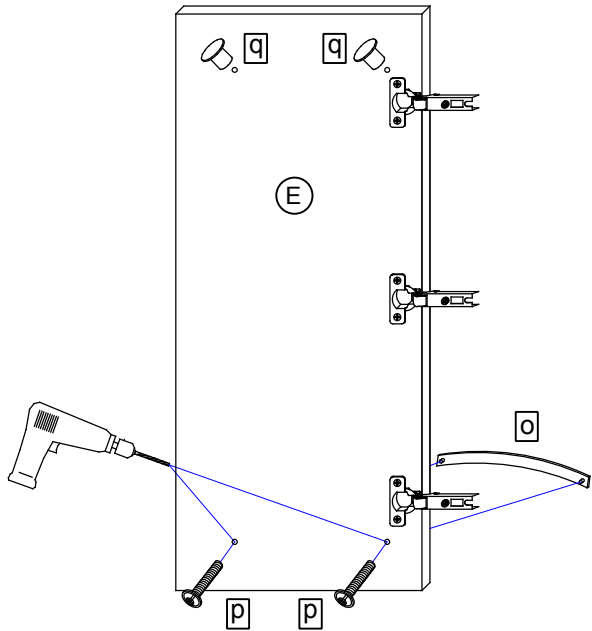
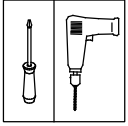

8.1

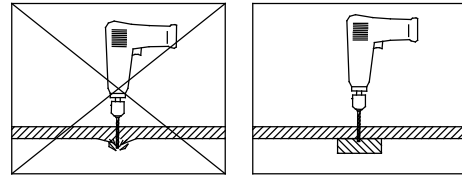

8.2

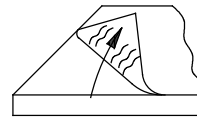

Bei Hochglanz-Fronten bitte erst die Schutzfolie entfernen und dann den Griff montieren!

8.3

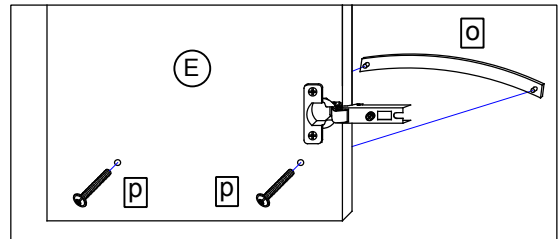

9.

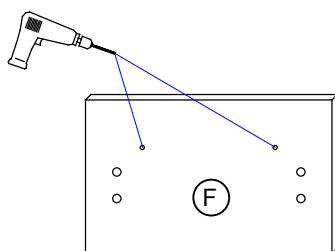
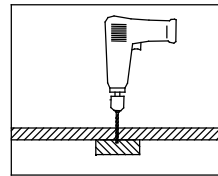
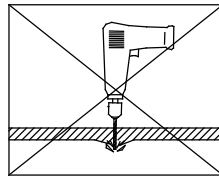
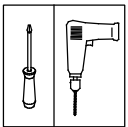

IT09

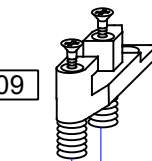

IT09

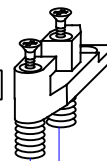

F

10.

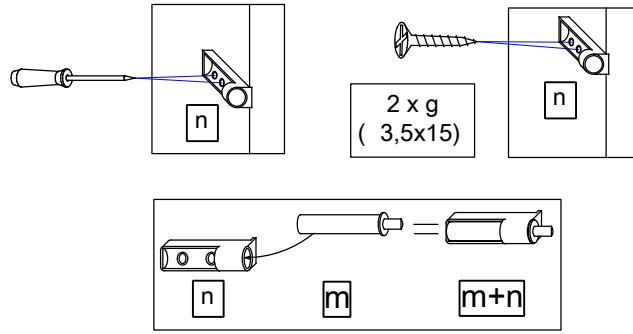
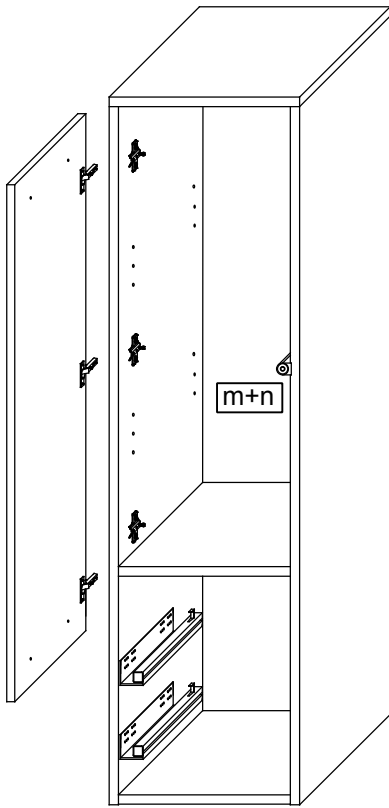
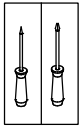

Bei Türmontage das Scharnier einhängen, bis Anschlag öffnen und anschließend festschrauben.

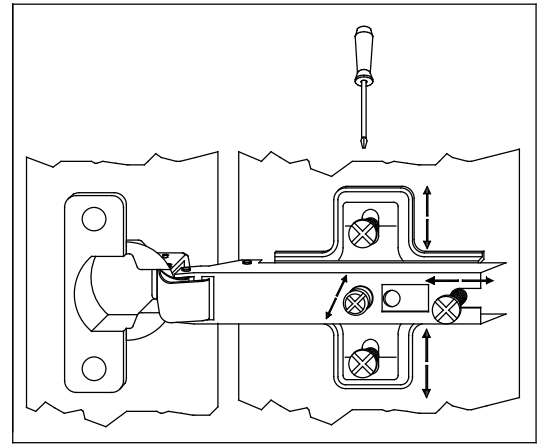
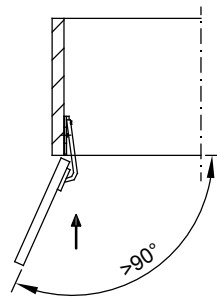

11.

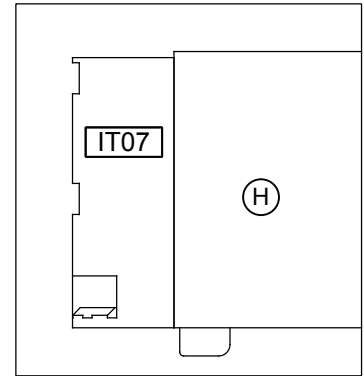
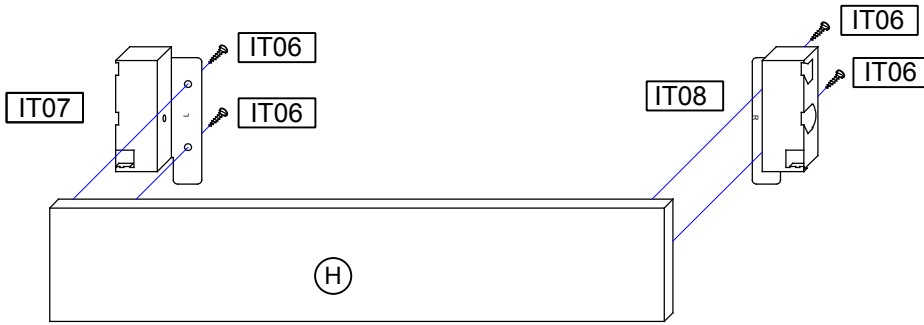
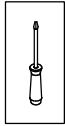

12.

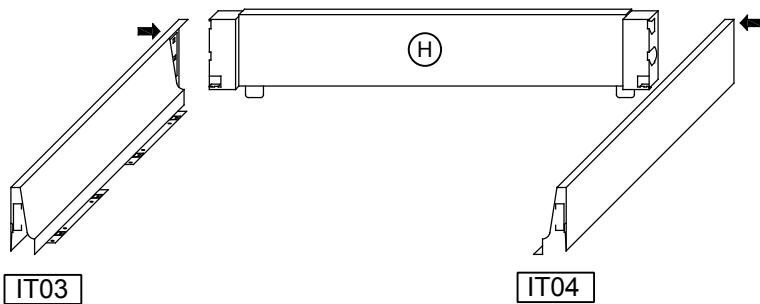

13.

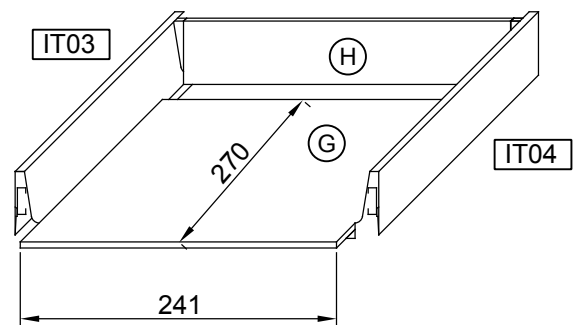

14.

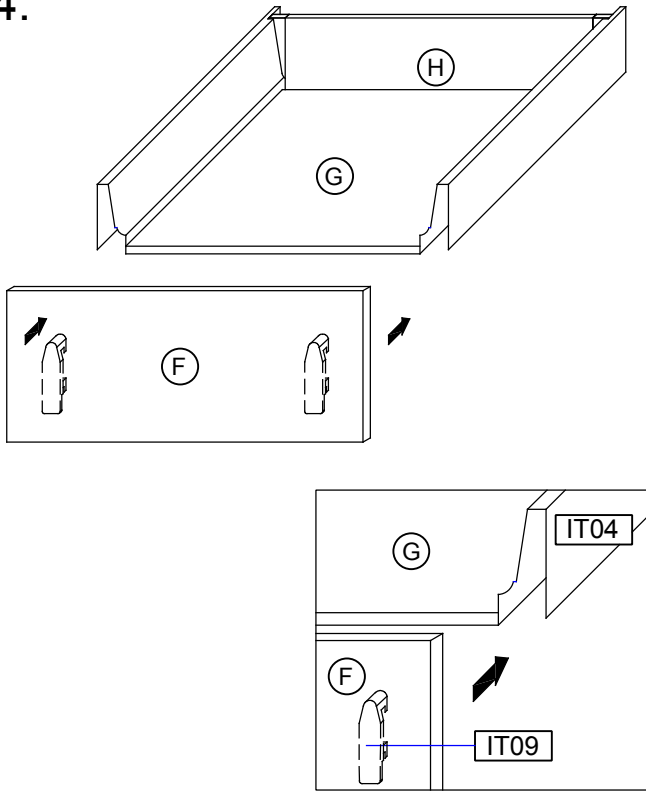

15.

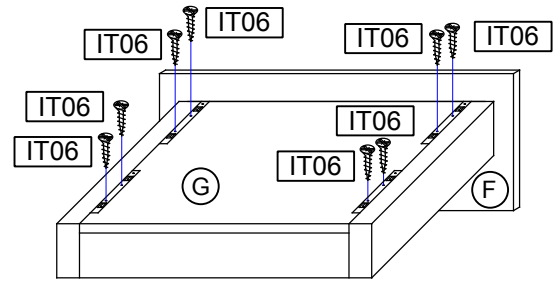
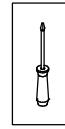

16.

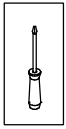

Bei Hochglanz-Fronten bitte erst die Schutzfolie entfernen und dann den Griff montieren!

16.1

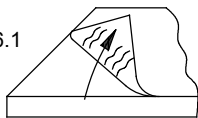

16.2

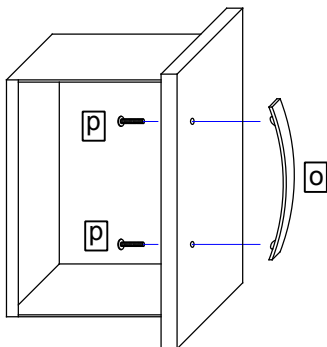

17.

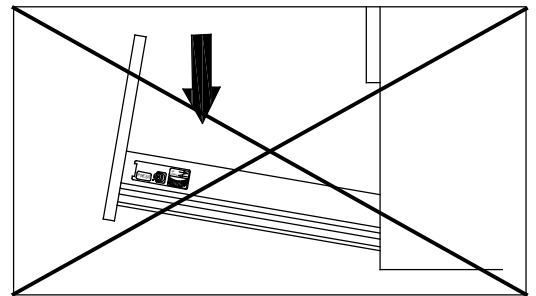
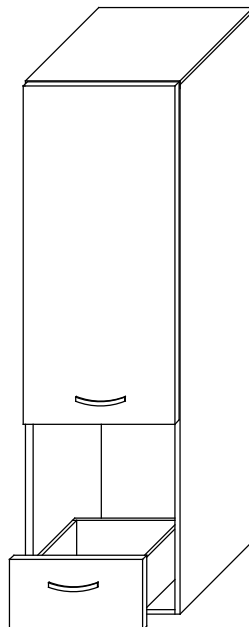

17.1

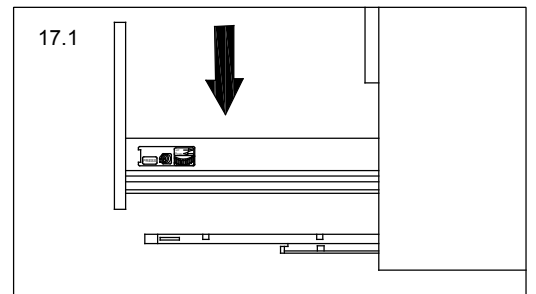

17.2

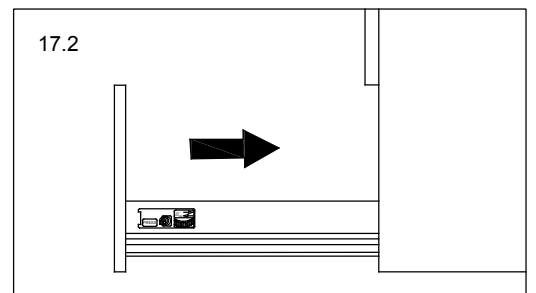

18.

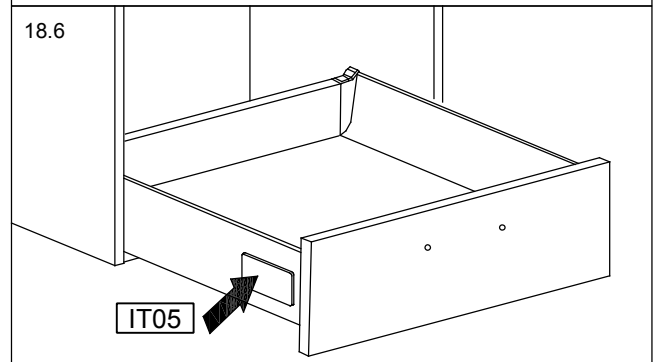
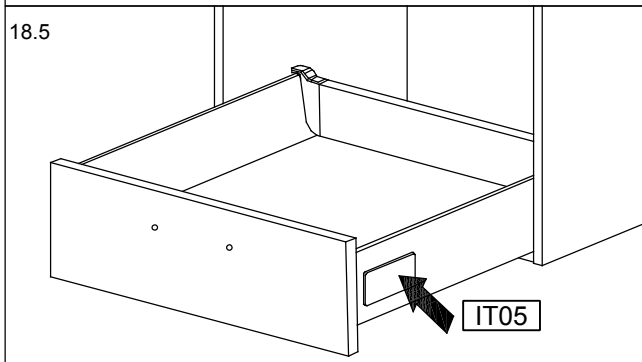
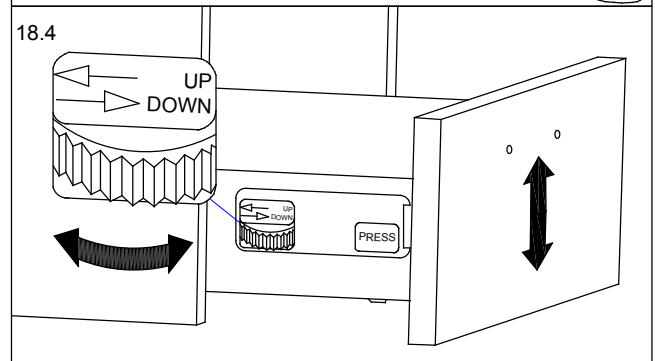
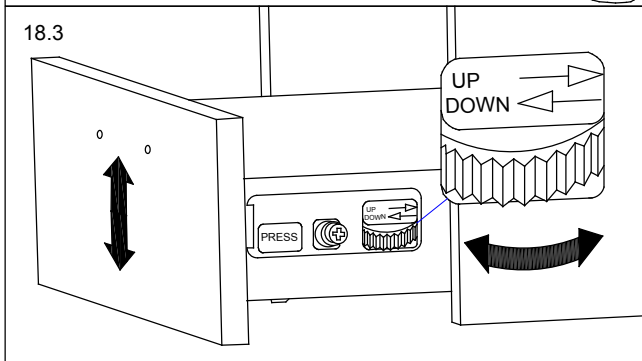
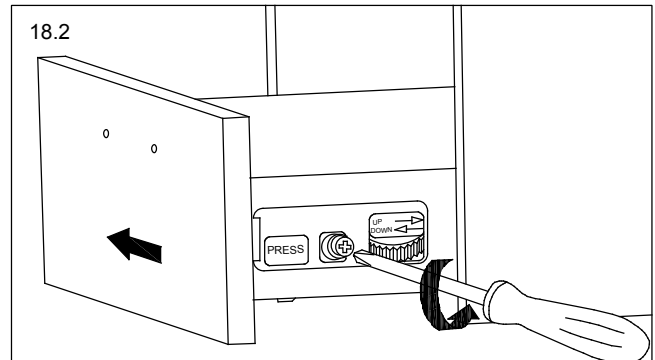
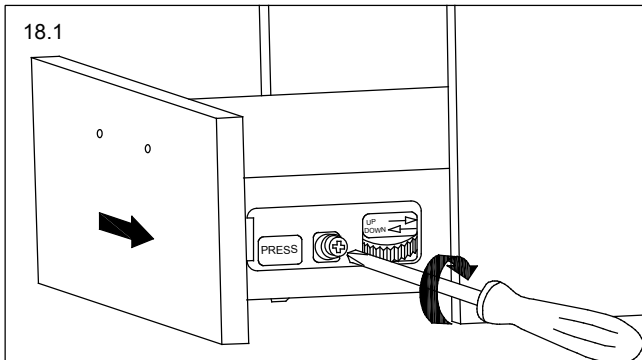
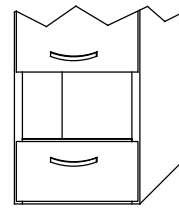
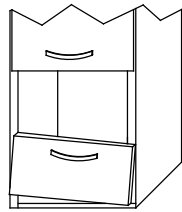
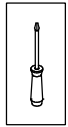

19.

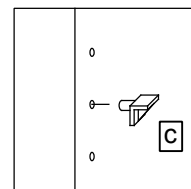
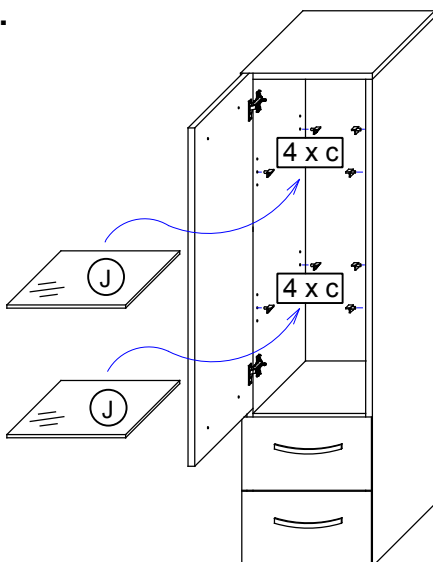

T12 Das Möbel bitte nur mit einem feuchten Tuch reinigen.