

DESIGN + ENGINEERING  
GROHE GERMANY

99.1636.031/ÄM 250222/08.21

www.grohe.com

*Pure Freude  
an Wasser*

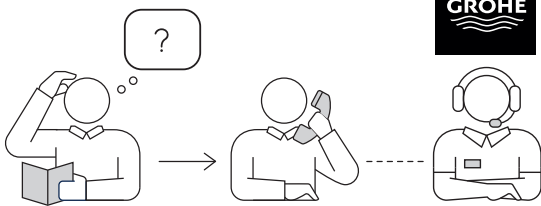
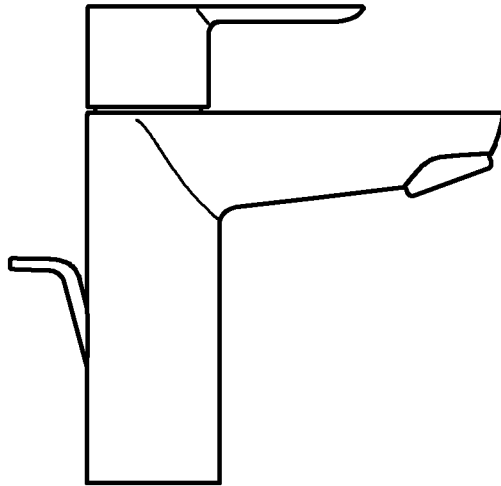



DIN  
1988

DIN EN  
806

**bar**

max. 10  
0,5 5 1

**°C**

max. 70° 60°

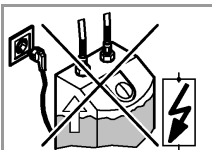

13mm  
19mm  
22mm

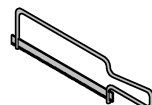
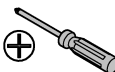

1

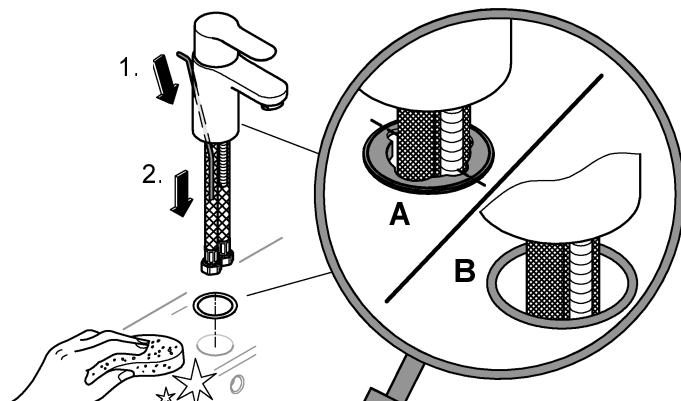

2

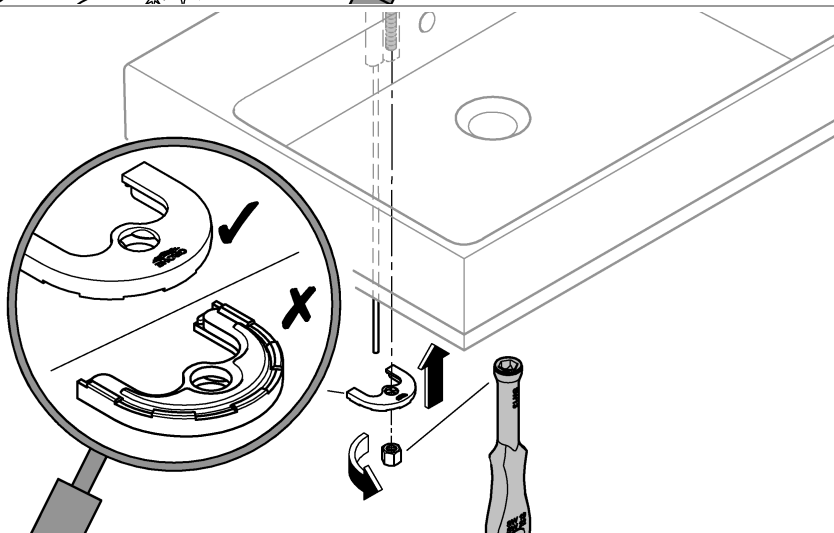

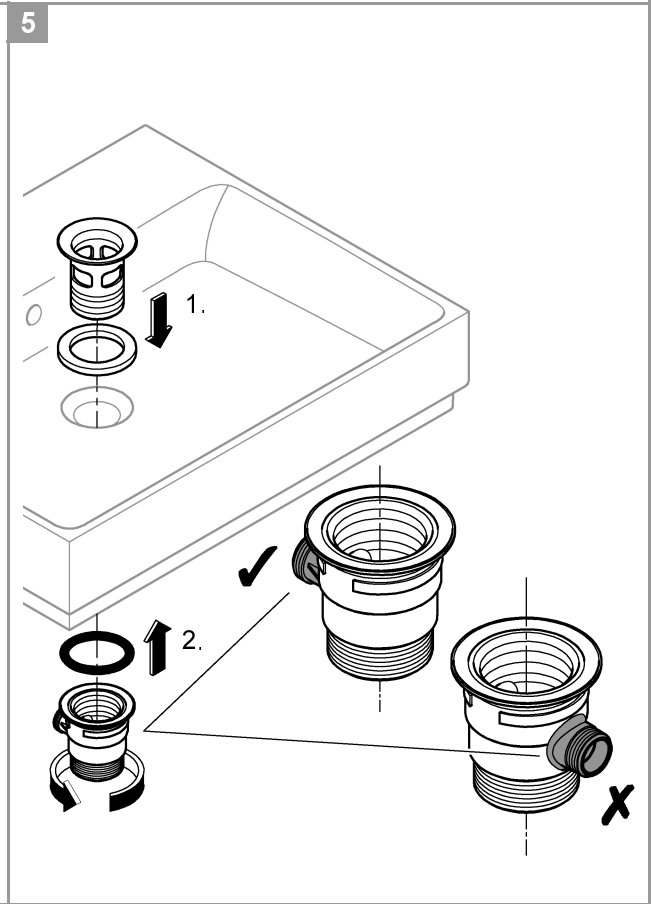
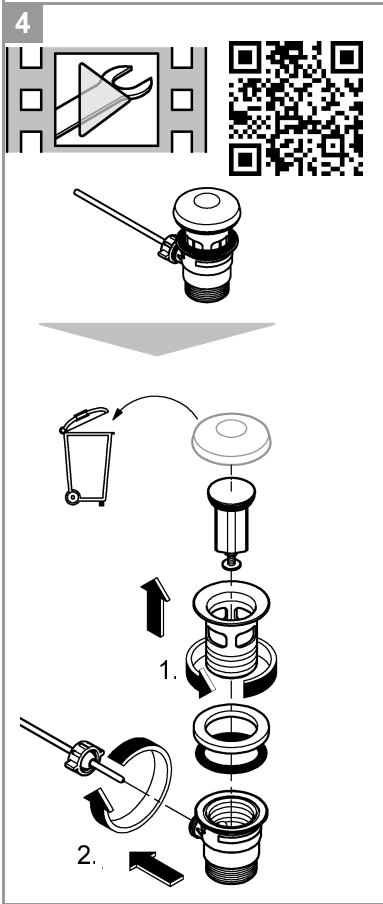
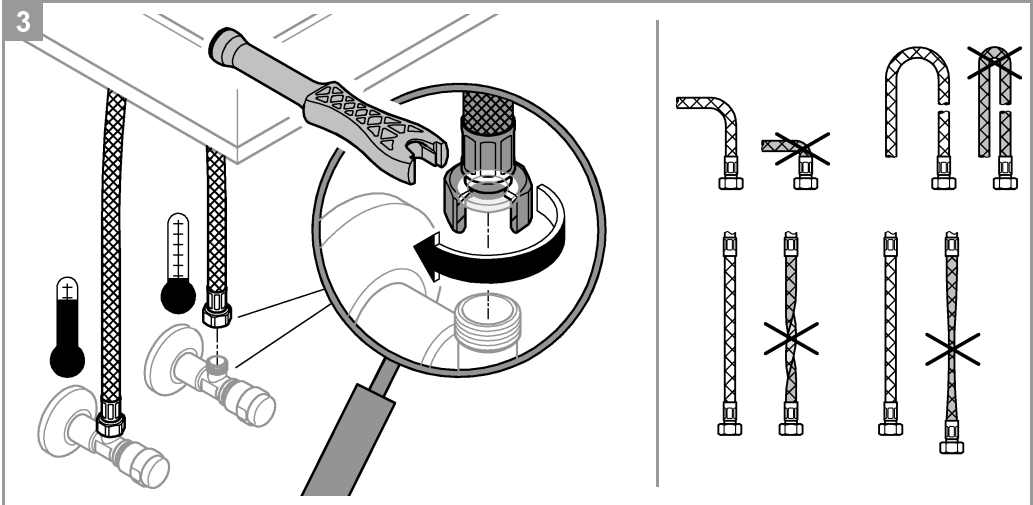

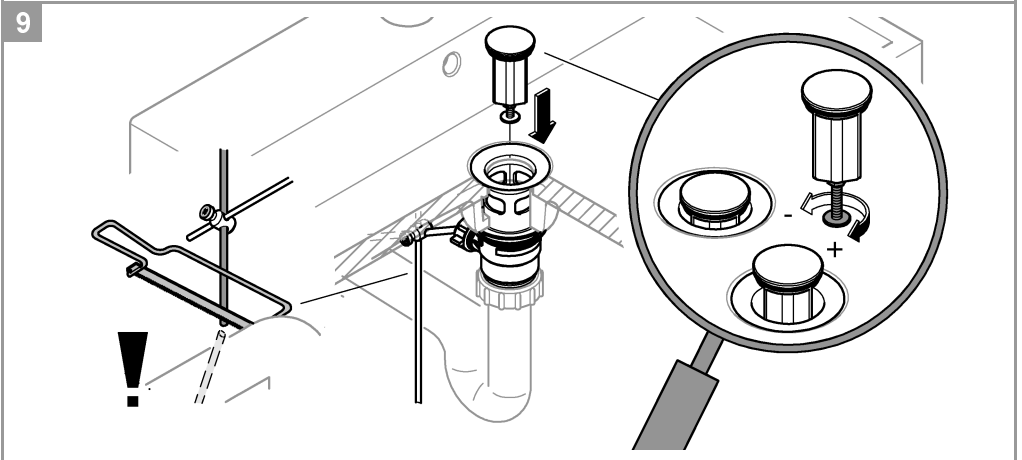
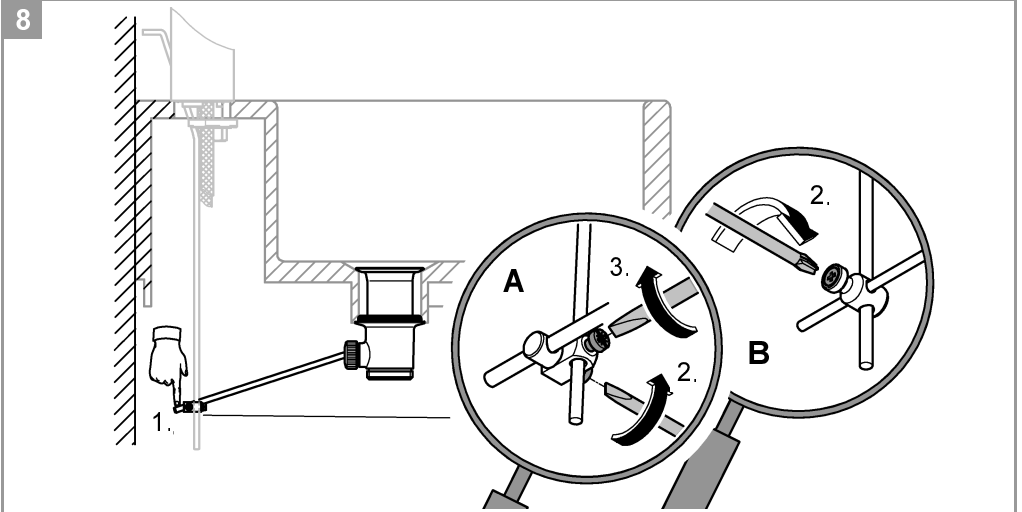
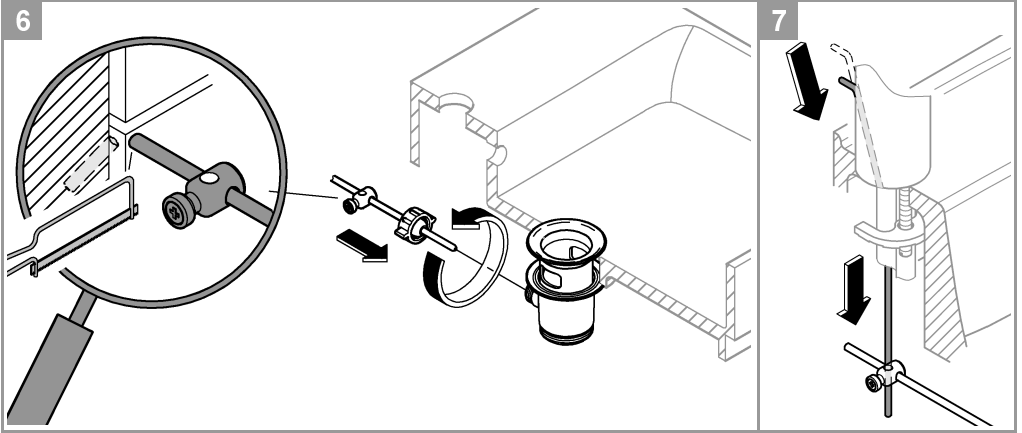

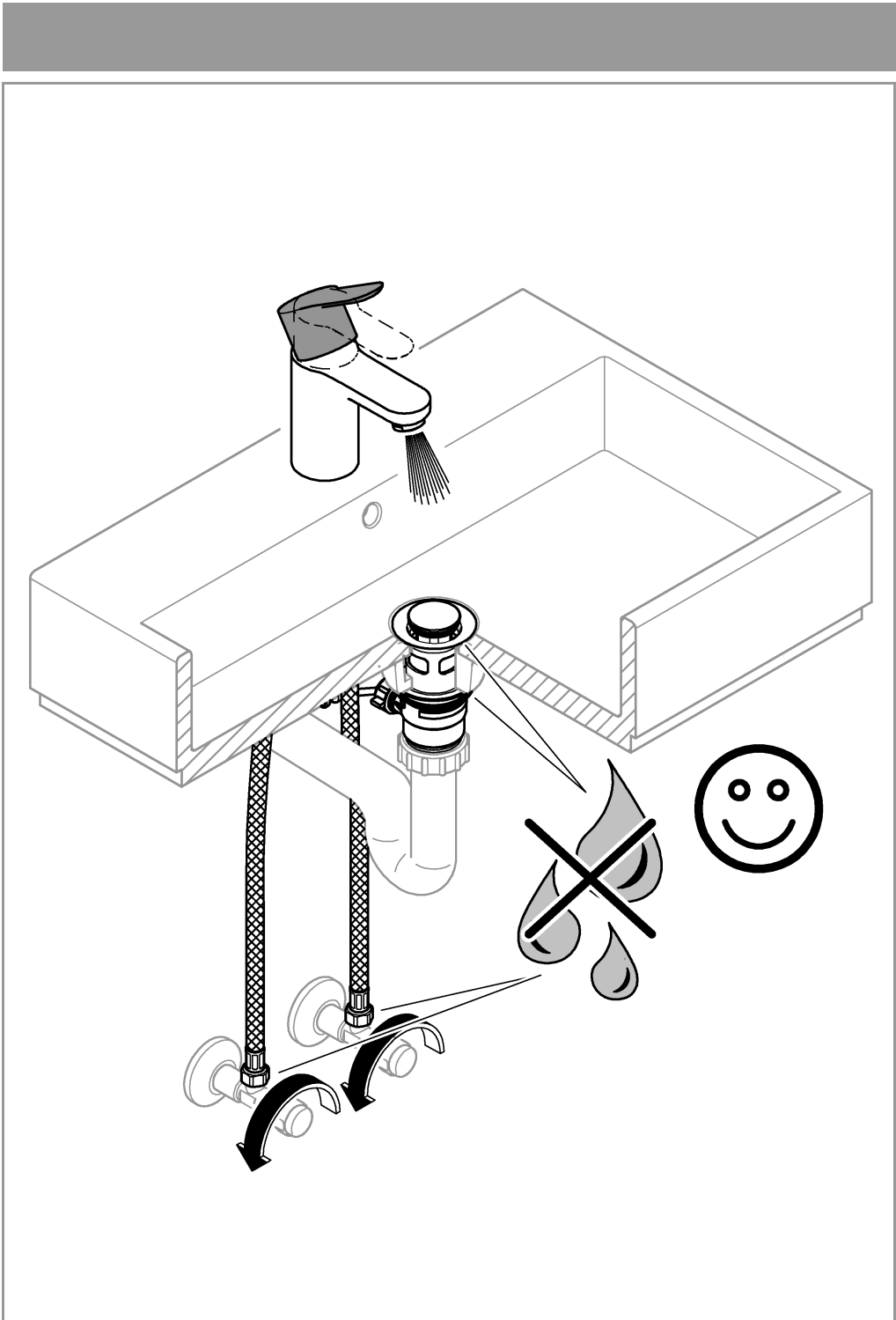



A series of horizontal lines for writing, consisting of 25 evenly spaced lines extending across the width of the page.