

MONTAGEANLEITUNG

Hochbeet

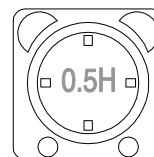
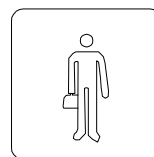
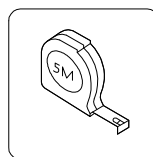
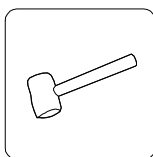
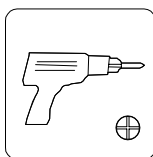
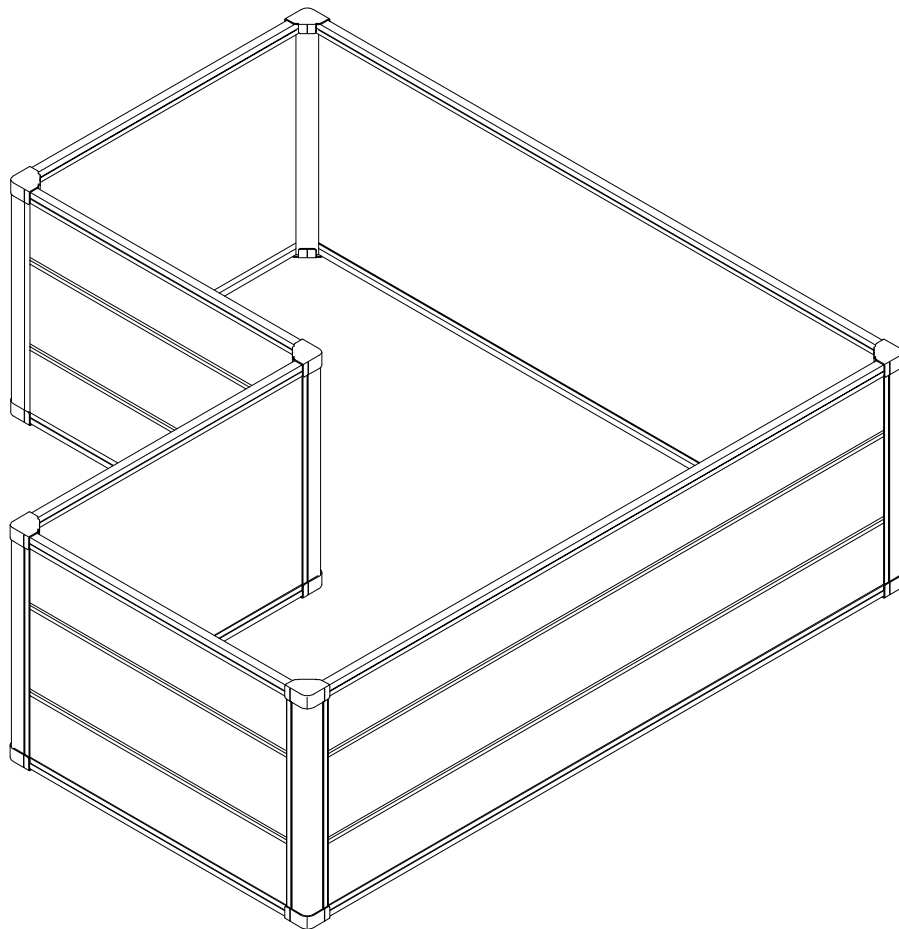

**BEI FRAGEN, KONTAKTIEREN SIE
UNSEREN KUNDENSERVICE:**

50NRTH GmbH
Straßburgstraße 14-16
D-54516 Wittlich

service@50NRTH.com
+49 (0) 6571 95117-0

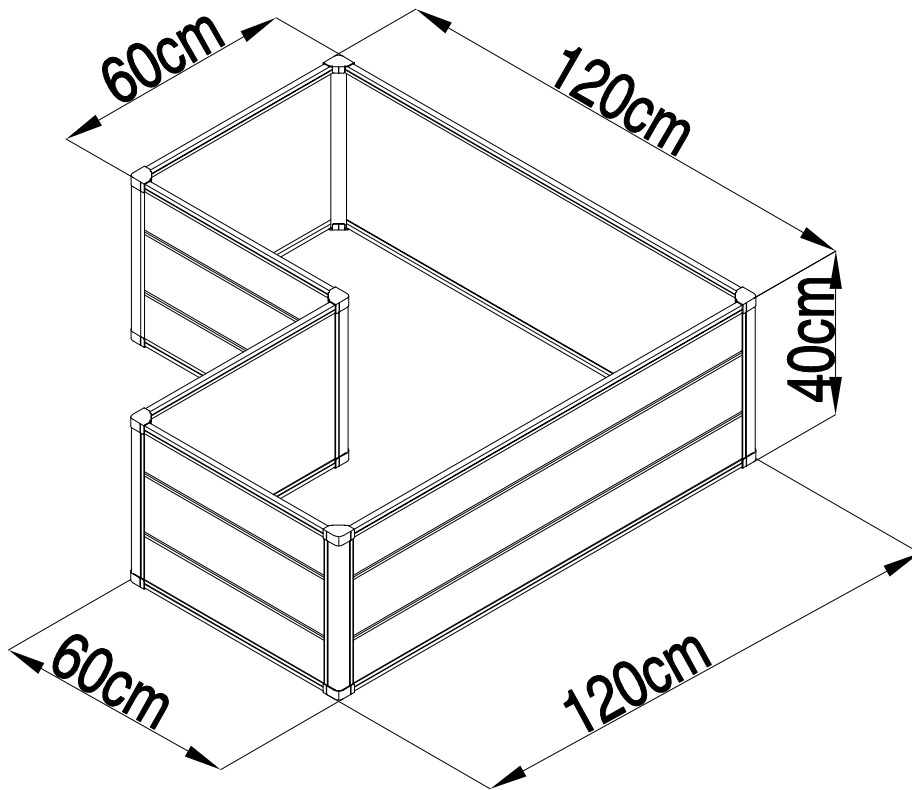

Benötigtes Aufstellmaß :

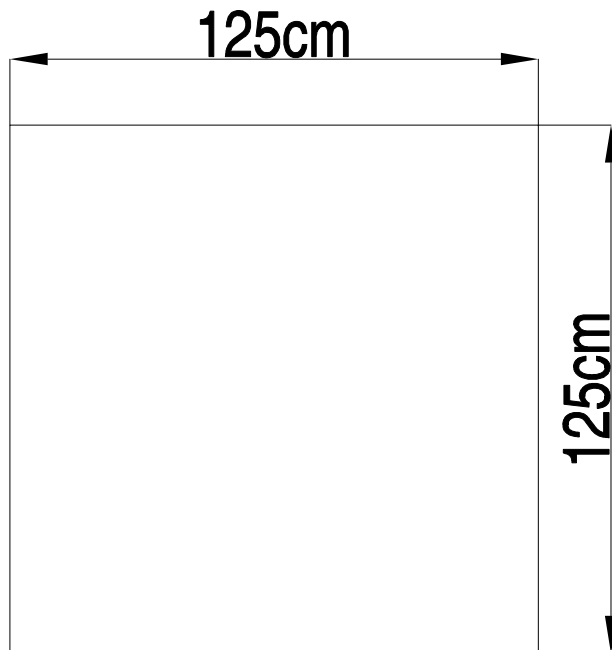



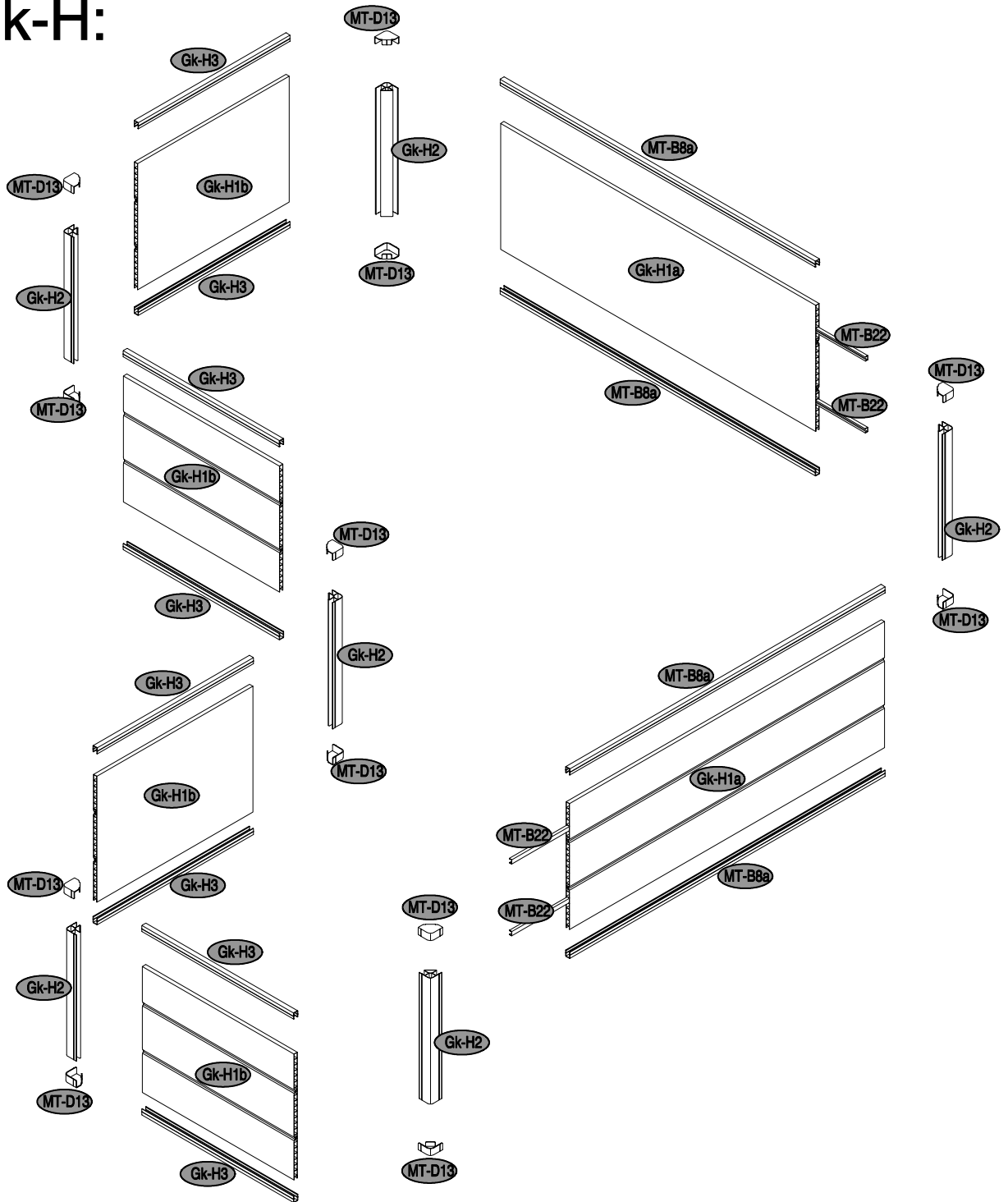

Gk-H:

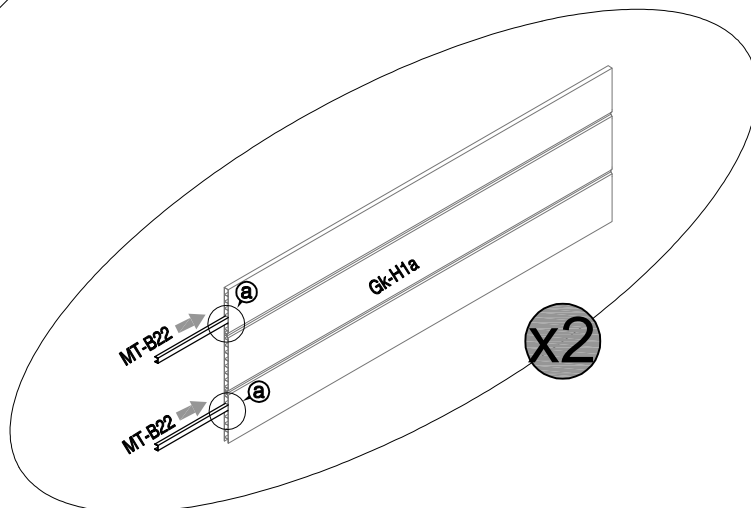
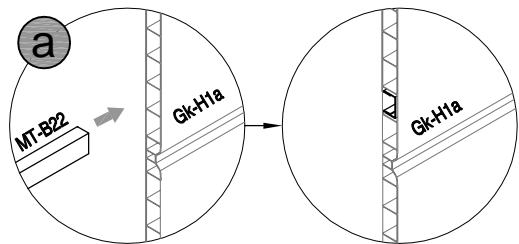

NO.	IMAGE	mm	QTY
Gk-H1a		1156	x2
Gk-H1b		564	x4
Gk-H2		400	x6
MT-B22		1156	x4
MT-B8a		1154	x4
Gk-H3		562	x8
MT-D13			x12
Gk-H44		ST4.2x13	x48

1	 Gk-H1a [x2]	 MT-B22 [x4]	
----------	--	--	--



2	 Gk-H1b [x4]	 Gk-H2 [x6]	 Gk-H44 [x24]	
----------	--	---	---	--

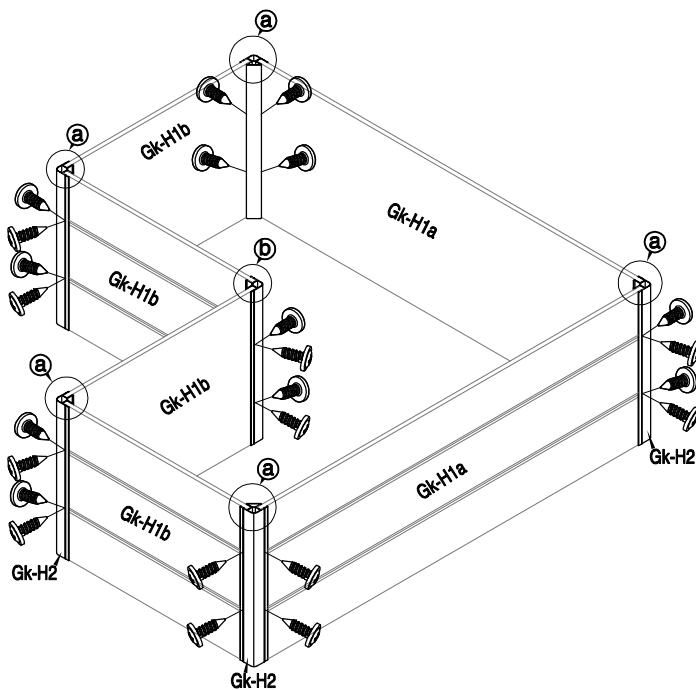
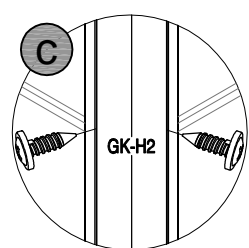
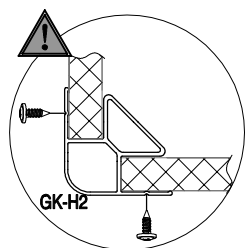
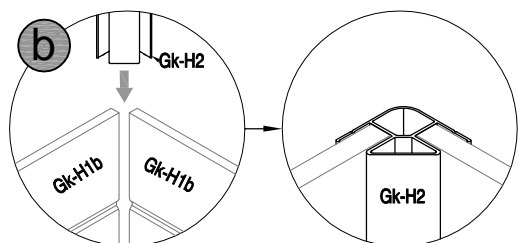
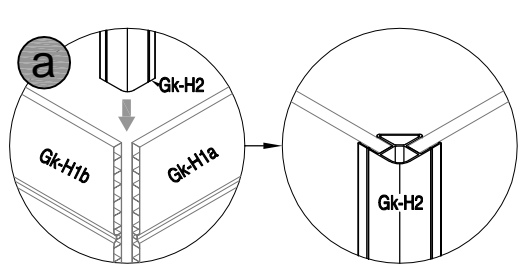

3	 MT-B8a [x4]	 Gk-H3 [x8]	
----------	--	---	--

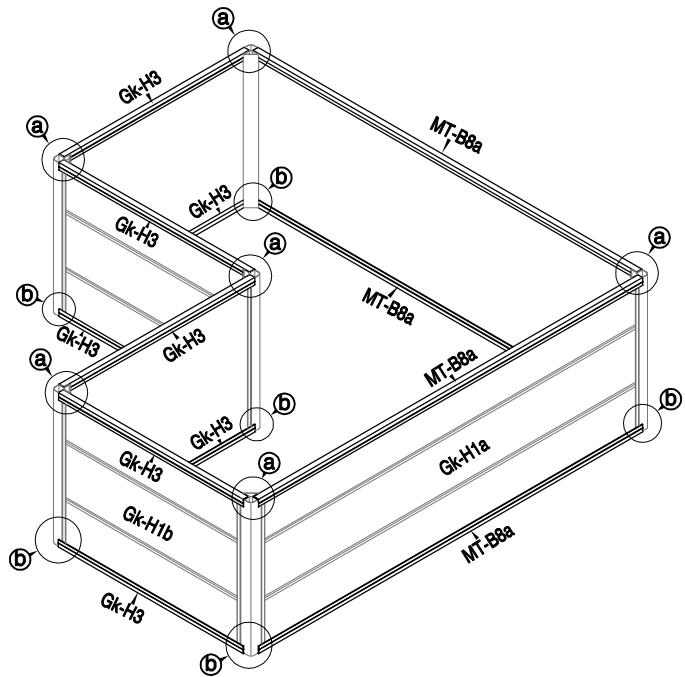
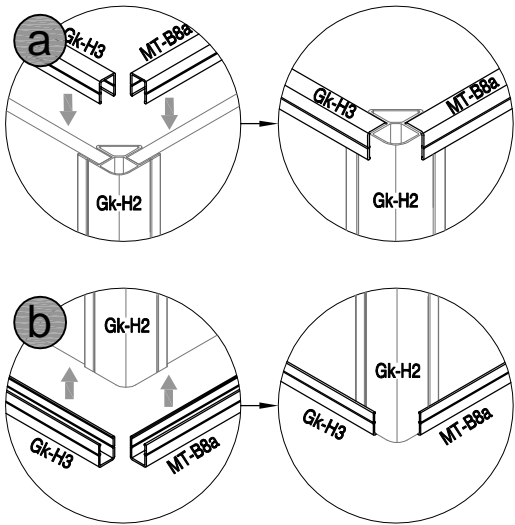

4	 MT-D13 [x12]	 Gk-H44 [x24]	
----------	---	---	--

